

# 2023

C A T Á L O G O

DESSINE

PENSE LUZ



DESSINE

C A T Á L O G O

2 0 2 3

## DESSINE | CATÁLOGO 2023

Copyright® 2001-2023, DESSINE Comércio de Artigos de Iluminação. Todos os direitos reservados.

Todos os textos, imagens, gráficos, produtos e outros materiais são protegidos por direitos autorais e outros direitos de propriedade intelectual pertencentes à DESSINE Comércio de Artigos de Iluminação, suas subsidiárias, afiliadas e licenciantes.

A DESSINE Comércio de Artigos de Iluminação é, também, proprietária dos direitos autorais de desenvolvimento, seleção, coordenação, diagramação e disposição dos materiais neste catálogo.

É expressamente vedada a cópia ou reprodução destes materiais para uso ou distribuição comercial, a modificação destes materiais, sua inclusão em outros sítios, e o seu envio e publicação em outros meios digitais e físicos, ou de qualquer outra forma dispor de tais materiais sem a devida autorização, estando sujeito às responsabilidades e sanções legais.

Design e Imagens da Seção de Produtos: Márcio Maciel  
Capa, Introdução e Direção Final de Arte: Andrés Gianni

Todos os produtos são assinados pelo designer **Raffa Andrade**

w w w . d e s s i n e . c o m . b r

ESSINZE  
PENSE LUZ

**Vivemos de luz.** Para nós, luz é conceito,  
energia vital. É contraste, ousadia,  
criação. Desafio, beleza, simplicidade,  
inteligência, tecnologia, economia.  
Para nós, luz é tudo. É vida. **Somos luz.**







**10** INSTITUCIONAL

**26** ÍNDICE DE PRODUCTOS

**28** ÍNDICE VISUAL

**30** PRODUCTOS

31 EMBUTIR

113 EXTERNO

139 SOBREPOR

149 SPOTS

159 PERFIS

187 ARANDELAS

199 SISTEMAS

227 TELA TENSIONADA

**230** CONTATOS



# REFERÊNCIA NA ARTE DE ILUMINAR

Com sede em Brasília, e com mais de 20 anos de atuação no mercado, a **Dessine** se consolidou como referência técnica em lighting design, com uma grande bagagem de projetos residenciais e corporativos, além de uma longa experiência na comercialização de produtos de iluminação técnica e decorativa.

O conhecimento acumulado nessa trajetória, somado à paixão pelo design de luz e pela inovação, impulsionou a abertura de sua fábrica, também na Capital Federal, onde hoje é produzida uma ampla linha de perfis e luminárias com LEDs integrados de alta qualidade, que colocam a empresa também como referência dos segmentos de iluminação premium e de luxo no mercado nacional.

Além da fábrica, a Dessine mantém um grande showroom, no formato de Experience Store, do qual faz parte também o Lighting LAB, espaço criado para que os clientes da empresa possam conhecer e experimentar componentes, cores, dimerização avançada, comandos de automação e todos os detalhes técnicos relacionados à arte luminotécnica.





SHOWROOM  
DESSINE  
BRASÍLIA-DF



DES

SSINE

FÁBRICA DESSINE  
BRASÍLIA-DF





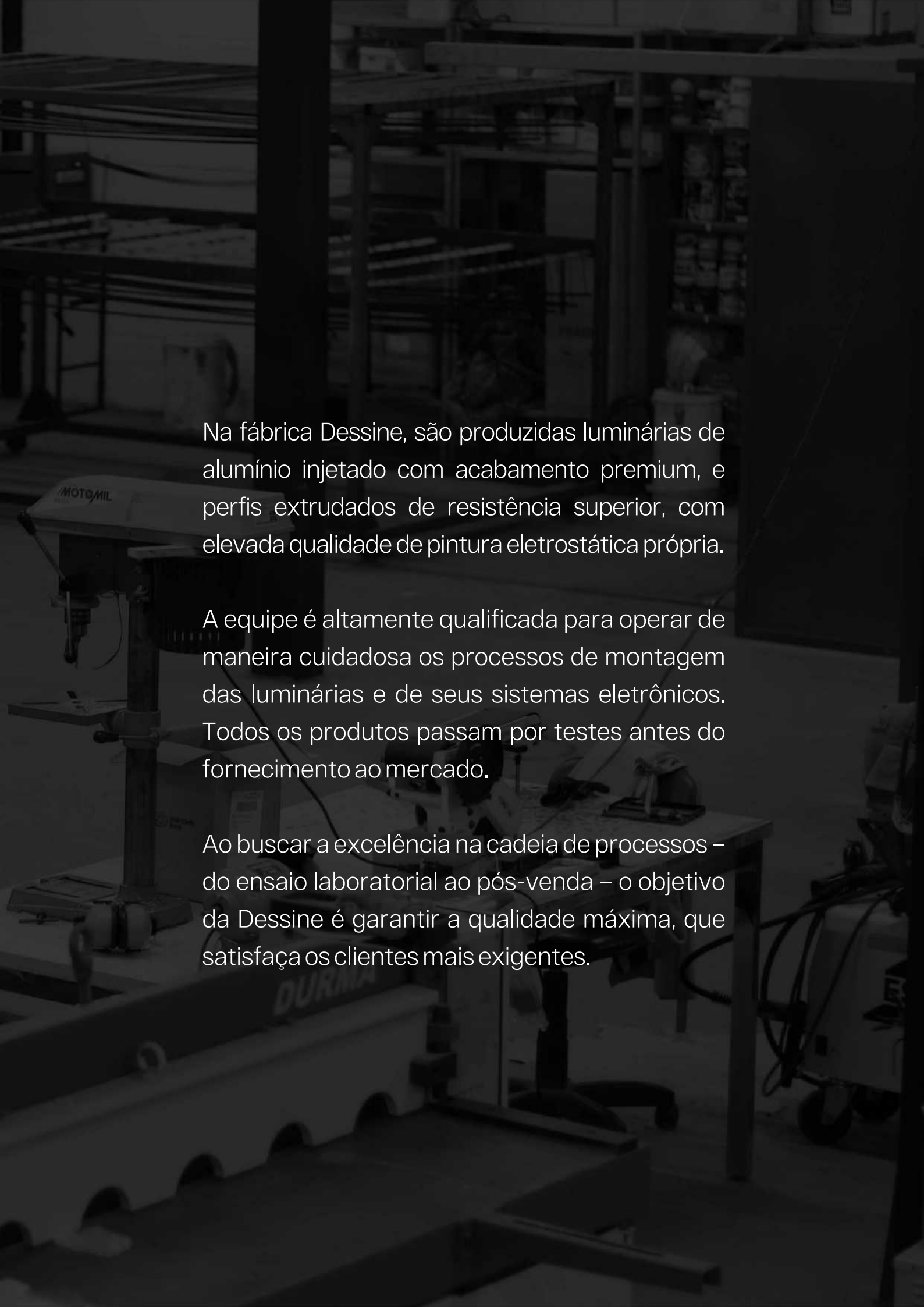

Na fábrica Dessine, são produzidas luminárias de alumínio injetado com acabamento premium, e perfis extrudados de resistência superior, com elevada qualidade de pintura eletrostática própria.

A equipe é altamente qualificada para operar de maneira cuidadosa os processos de montagem das luminárias e de seus sistemas eletrônicos. Todos os produtos passam por testes antes do fornecimento ao mercado.

Ao buscar a excelência na cadeia de processos – do ensaio laboratorial ao pós-venda – o objetivo da Dessine é garantir a qualidade máxima, que satisfaça os clientes mais exigentes.

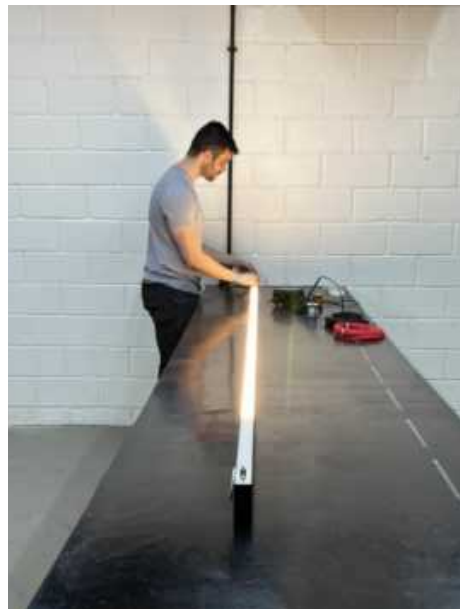



Laboratório de medição de distribuição de luz e curva fotométrica de luminárias



A cada  
novo projeto,  
uma solução  
inovadora

Inovação e maestria fazem parte do DNA da Dessine.

Nosso departamento de Pesquisa & Desenvolvimento tem o compromisso de trazer à luz novos conceitos, que antecipem e solucionem as demandas do mercado.

Da ideia criativa à fabricação, a responsabilidade de sempre entregar o melhor.



DESSINE

DESSINE

DESSINE

DESSINE

DESSINE

DESSINE

DESSINE

DESSINE

DESSINE

DESSINE

DESSINE

DES10000014-60A-DC-A00

6FF 0522

DES10000014-60A-DC-A00

6FF 0522

DES10000014-60A-DC-A00

6FF 0522

DES10000014-60A-DC-A00

6FF 0522

DES10000014-60A-DC-A00

6FF 0522

Tc IR1 R4 R9

Tc IR1 R4 R9

Tc IR1 R4 R9

Tc IR1 R4 R9

Tc IR1 R4 R9

Tc IR1 R4 R9

Tc IR1 R4 R9

Tc IR1 R4 R9

Tc IR1 R4 R9

Tc IR1 R4 R9

Tc IR1 R4 R9

R3

R3

R3

R3

R3

R3

R3

R3

R3

R3

R3

## Tecnologia LED com eficiência e máxima fidelidade

A partir da consciência e da responsabilidade de fazer uso racional dos recursos energéticos do planeta, a Dessine desenvolve sistemas de LEDs altamente eficientes, em sintonia com o melhor da tecnologia disponível no mercado mundial.

Para as linhas de produtos, a empresa seleciona os LEDs mais modernos e com melhores características para a iluminação, como IRC > 90 (alta fidelidade de cor) e STEP < 3 (padronização de cores dos LEDs), com drivers de última geração para dimerização de precisão. Tudo sempre na direção de buscar a luz com máxima fidelidade de renderização de cores, assim como de eficácia luminosa.

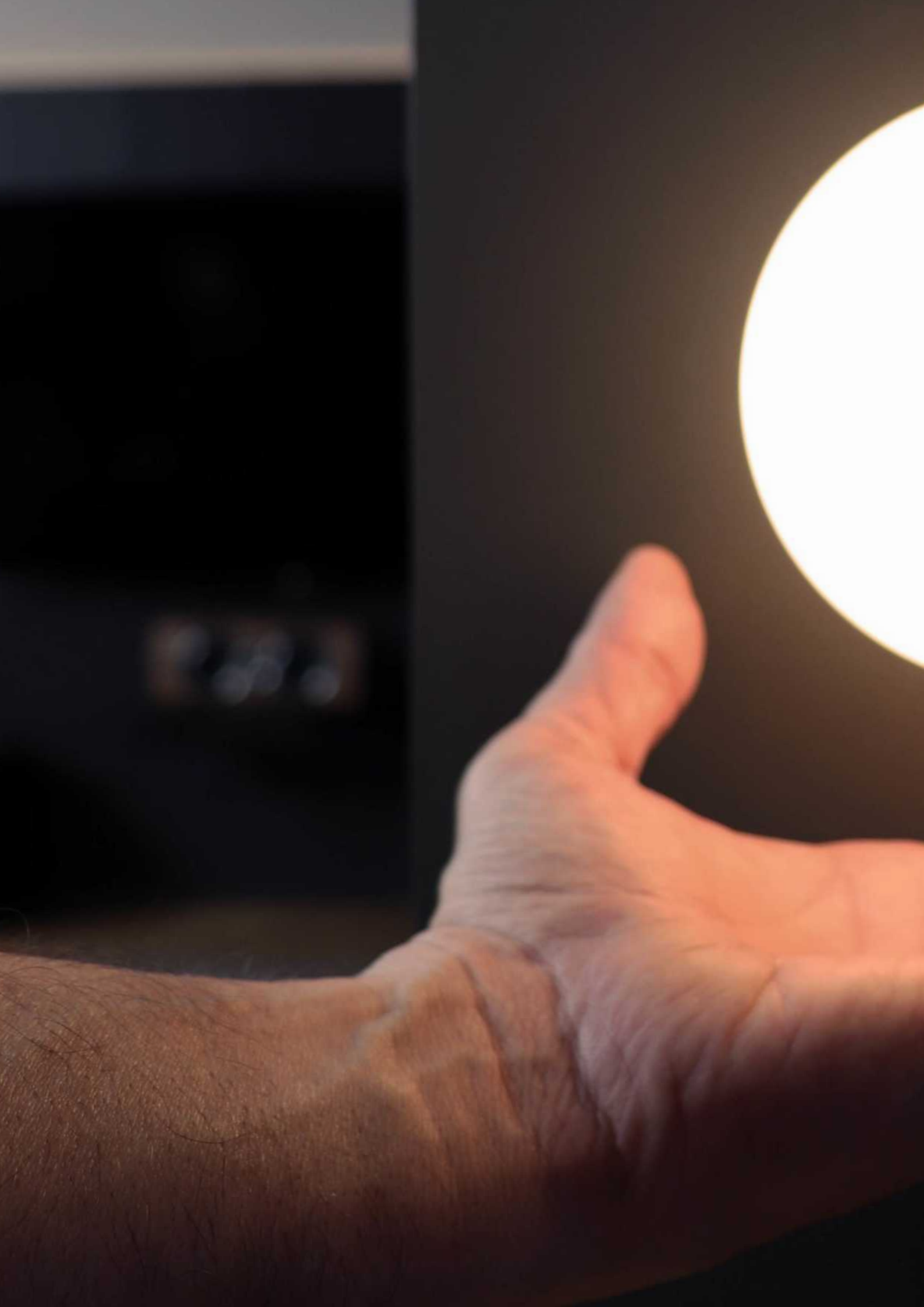







## EMBUTIR

- 32 IVE
- 36 VINE
- 40 MASK
- 44 CHIC
- 48 MINI CHIC
- 52 TINY
- 56 MINI ONNE
- 60 GRACE
- 64 OSLO
- 68 SIMME
- 72 BEAN
- 76 BOWL
- 80 SIMPLE
- 84 ALPHA
- 88 DELTA
- 92 VICK
- 96 VICK WALLWASHER
- 100 VICK LT
- 104 VICK SQUARE
- 108 VAN

## EXTERNO

- 114 UNDER COMB
- 118 UNDER WALLWASHER
- 122 UNDER MINI
- 126 UNDER MICRO
- 130 GROUND
- 134 TULIP

## SOBREPOR

- 140 MOSS
- 144 OSLO

## SPOTS

- 150 TUBE
- 154 FINN

## PERFIS

- 160 MAKE
- 164 MINI INFINITY
- 166 RAGGIO
- 170 MINI RAGGIO
- 172 TRACCIA
- 174 TRECK
- 176 LIMIT
- 178 ASSY
- 180 PLY
- 182 ZERO G

## ARANDELAS

- 188 BENT
- 192 THIN
- 194 BOSS

## SISTEMAS

- 200 MASSIMO
- 208 INFINITY
- 216 MICRO RUNNING MAGNET
- 220 LINNES

## TELA TENSIONADA

- 228 FLEX LIGHT

# ÍNDICE VISUAL

## EMBUTIR



IVE



VINE



MASK



CHIC



MINI CHIC

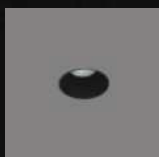

TINY



MINI ONNE



GRACE



OSLO



SIMME



BEAN



BOWL



SIMPLE



ALPHA



DELTA

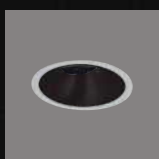

VICK

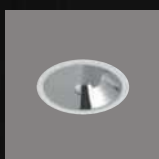

VICK  
WALLWASHER

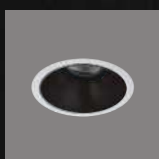

VICK LT

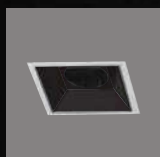

VICK  
SQUARE



VAN

---

## EXTERNO



UNDER  
COMB

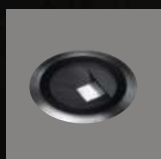

UNDER  
WALLWASHER



UNDER  
MINI



UNDER  
MICRO



GROUND



TULIP

## SOBREPOR



MOSS



OSLO

## SPOTS



TUBE



FINN

## PERFIS



MAKE



MINI  
INFINITY



RAGGIO



MINI  
RAGGIO



TRACCIA



TRECK



LIMIT



ASSY



PLY



ZERO G

## ARANDELAS



BENT



THIN



BOSS

## SISTEMAS



MASSIMO



INFINITY



MICRO  
RUNNING  
MAGNET



LINNES

## TELA TENSIONADA



FLEX LIGHT



A dark, monochromatic photograph of a modern kitchen. The scene is dimly lit, with a large, light-colored rectangular light fixture on the ceiling. In the center, a stainless steel range hood is mounted above a cooktop. A large, light-colored island with a dark bowl on it is in the foreground. The background shows a kitchen with a window and a door. The text "EM BUT IR" is overlaid in the center.

EM BUT IR



# IVE

Sofisticada e prática, possui uma delicada micro borda, ideal para uma instalação rápida e limpa, com acabamento preciso. Ive possui excelente controle de ofuscamento e LED com  $Ra > 90$   $SDCM < 3$ .





#### INFORMAÇÕES GERAIS

Luminária em alumínio injetado

 2700K / 3000K / 4000K

CRI  
>90

 3-SDCM

 100-240V

 Dimerizável

 50 000 h

 650 lm / 1850 lm



# Concrete Box



O Concrete Box é um acessório que possibilita instalação de luminária embutida em laje e possui encaixe perfeito para a luminária Ive com alojamento para driver.

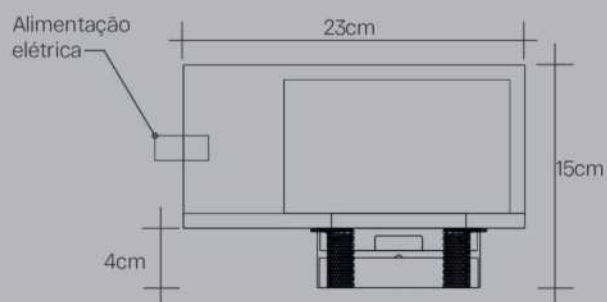

## INFORMAÇÕES ADICIONAIS

POTÊNCIA		FLUXO LUMINOSO [lm]
9 W	LED integrado	650
13 W	LED integrado	1320
18 W	LED integrado	1850
15 W	LED integrado - Luz difusa	1530

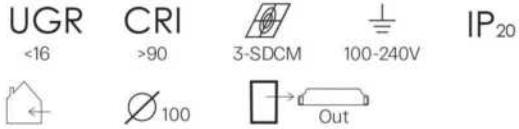

## CONTROLE



## AJUSTES

\*Para modelo Luz de Foco



## CORES



## DISTRIBUIÇÃO DE LUZ



## APLICAÇÃO



## DESENHOS TÉCNICOS

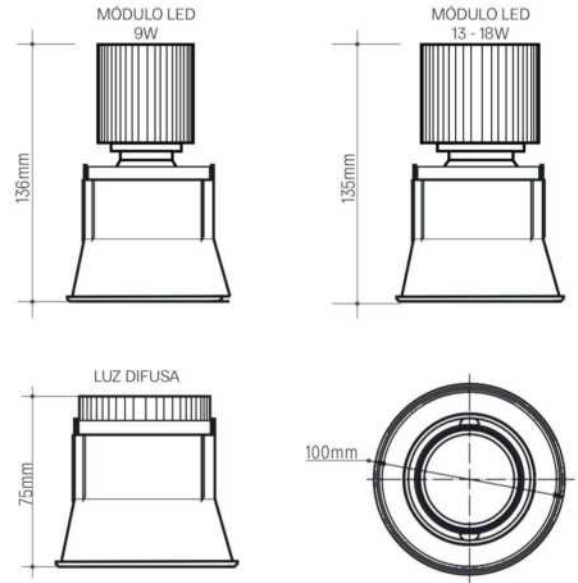

## CURVAS FOTOMÉTRICAS

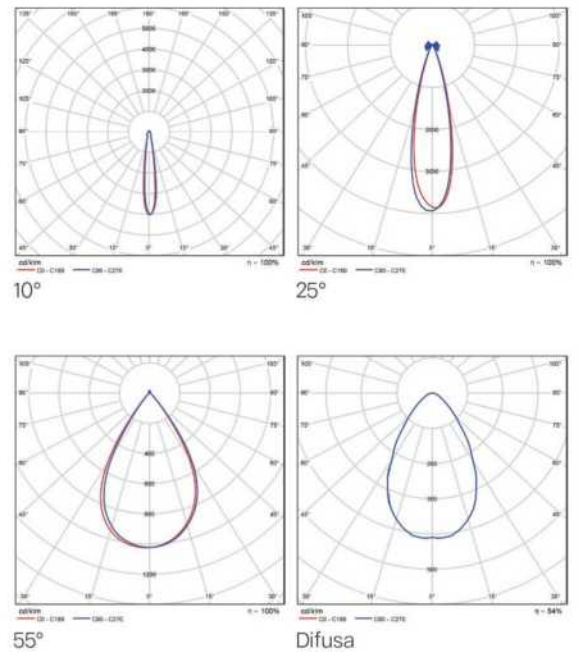



# VINE

Luminária em cobre natural para projetos que buscam requinte. Vine possui excelente controle de ofuscamento e LED com  $Ra > 90$   $SDCM < 3$ .



#### INFORMAÇÕES GERAIS

Luminária em cobre natural

 2700K / 3000K / 4000K

CRI  
>90

 3-SDCM

 100-240V

 Dimerizável

 50 000 h

 600 lm / 1530 lm

## INFORMAÇÕES ADICIONAIS

POTÊNCIA	FLUXO LUMINOSO [lm]
8 W	600
12 W	900
15 W	Luz Difusa 1530

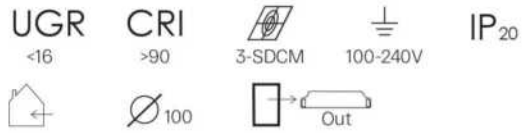

## CONTROLE



## AJUSTES

\*Para modelo Luz de Foco



## CORES



## DISTRIBUIÇÃO DE LUZ



## APLICAÇÃO



## DESENHOS TÉCNICOS

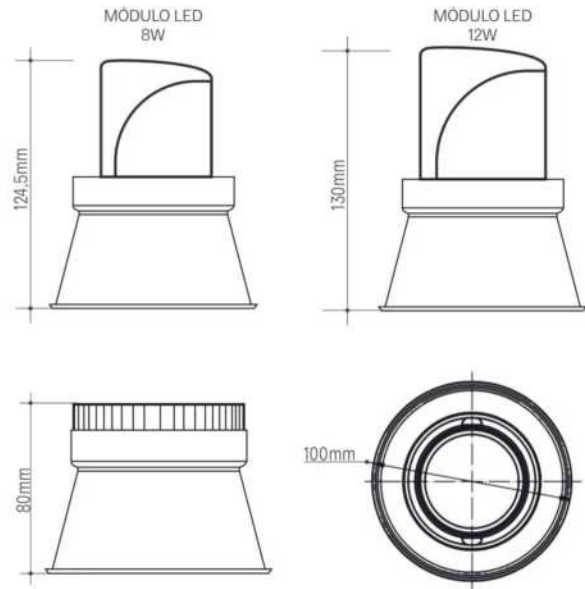

## CURVAS FOTOMÉTRICAS

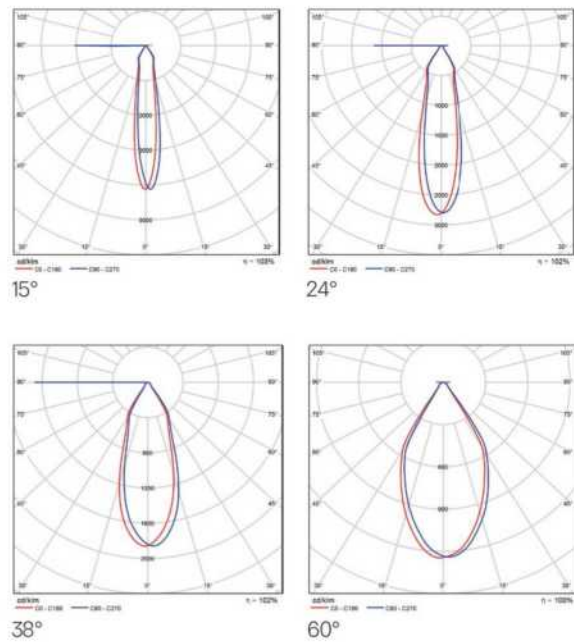





# MASK

A luminária Mask traz o conceito de dark light e proporciona um excelente conforto visual com seu exclusivo antiofuscante black glossy. Um efeito discreto e com fonte de luz praticamente imperceptível.





#### INFORMAÇÕES GERAIS

Luminária em alumínio injetado

 2700K / 3000K

CRI  
>95

 3-SDCM

 100-240V

 Dimerizável

 50 000 h

 600 lm / 900 lm

## INFORMAÇÕES ADICIONAIS

POTÊNCIA	FLUXO LUMINOSO [lm]
8 W	600
12 W	900

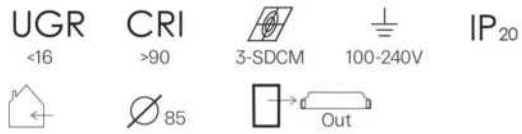

## CONTROLE



## AJUSTES



## CORES



## ANTIOFUSCANTE



## DISTRIBUIÇÃO DE LUZ



## APLICAÇÃO



## DESENHOS TÉCNICOS

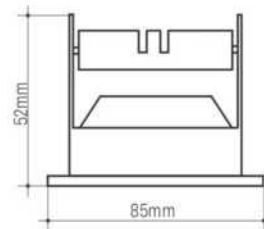
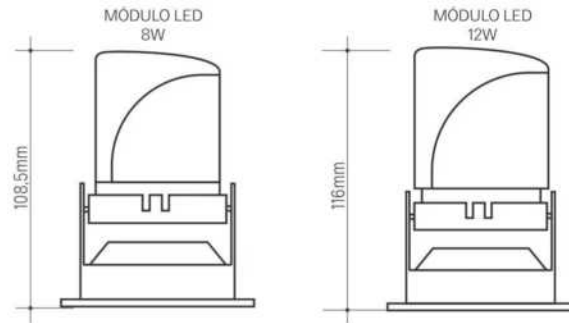

## CURVAS FOTOMÉTRICAS

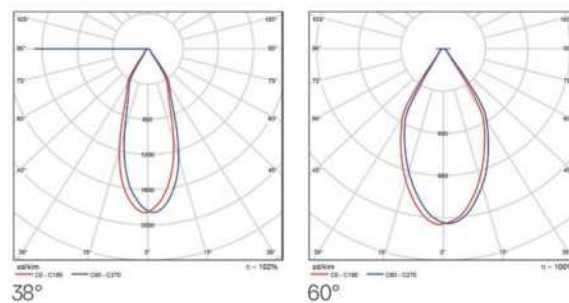
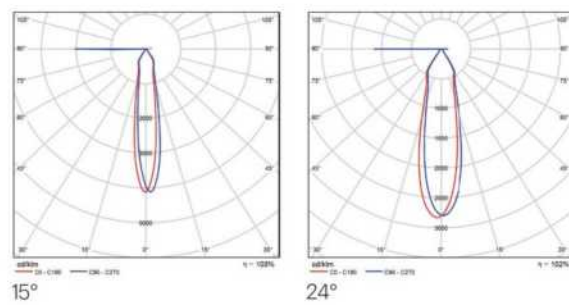





# CHIC

Luminária premium com características técnicas diferenciadas que possibilitam efeitos luminotécnicos em diferentes formatos de luz. Chic possui excelente controle de ofuscamento e LED com Ra>90 SDCM<3.

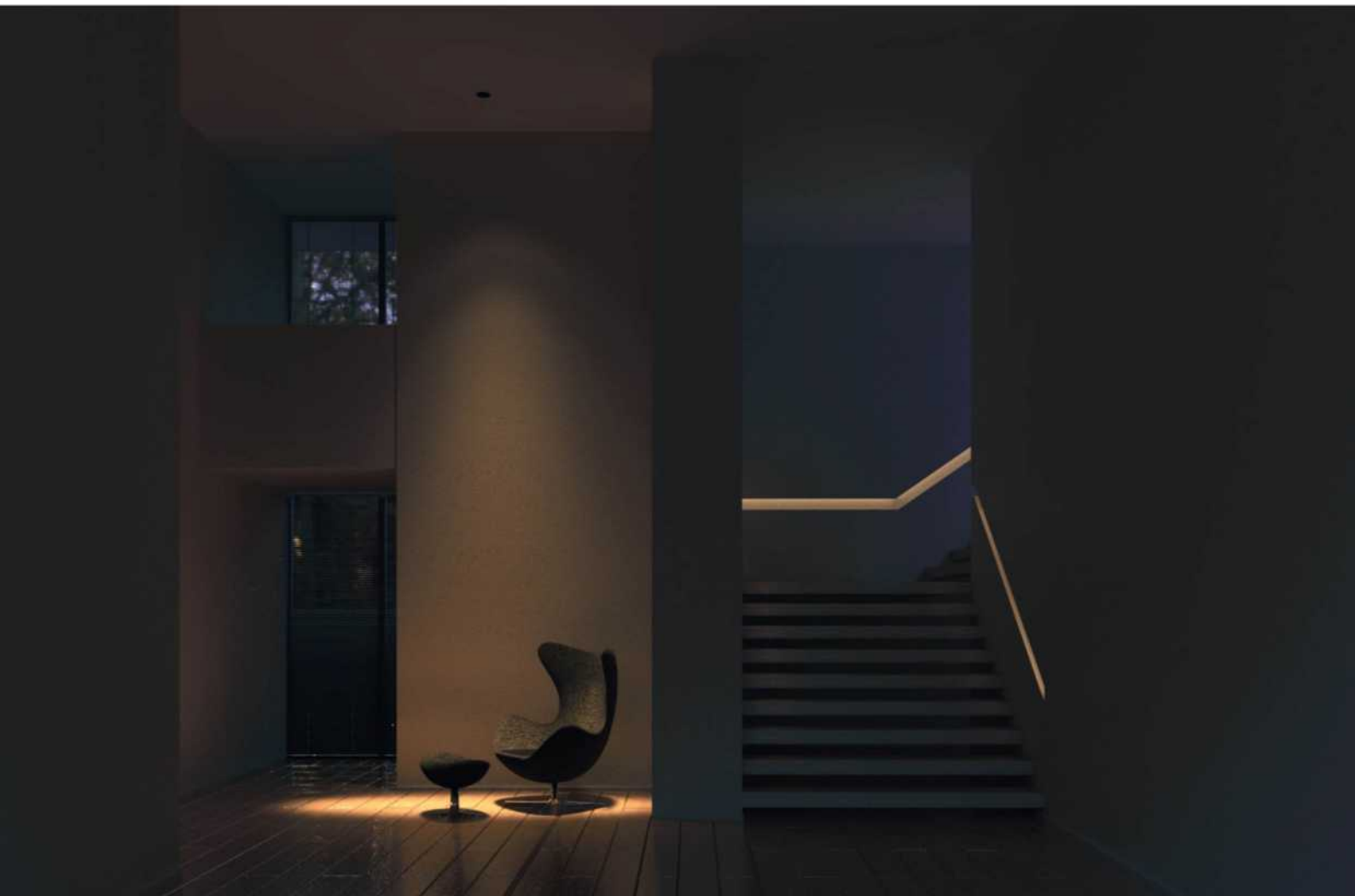

## INFORMAÇÕES GERAIS

Luminária em alumínio injetado



 2700K

CRI  
>90

 3-SDCM

 100-240V

 Dimerizável



 50 000 h

 780 lm

## INFORMAÇÕES ADICIONAIS

POTÊNCIA	FLUXO LUMINOSO [lm]
12 W	780

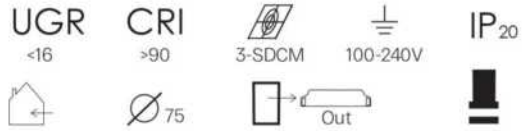

## CONTROLE



## AJUSTES



## CORES



## ANTIOFUSCANTE



## DISTRIBUIÇÃO DE LUZ



## APLICAÇÃO



## DESENHOS TÉCNICOS

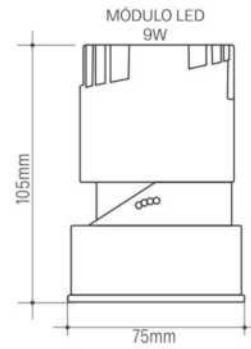

## CURVAS FOTOMÉTRICAS

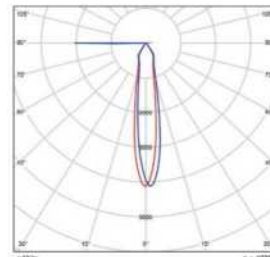

15°

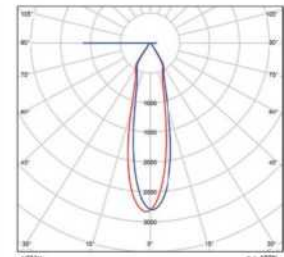

24°

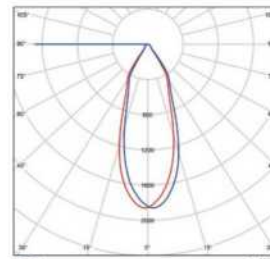

38°

## ACESSÓRIOS



FRINGE  
Efeito Quadrado



RHOMBIC  
Efeito Oval



HONEYCOMB  
Controle de Ofuscamento





# MINI CHIC

É refinada nos mínimos detalhes,  
e prática na medida certa. Uma  
miniatura ideal para ocupar  
qualquer ambiente e torná-lo  
agradável.





#### INFORMAÇÕES GERAIS

Luminária em alumínio injetado

 2700K / 3000K

CRI  
>90

 3-SDCM

 100-240V

 Dimerizável

 50 000 h

 450 lm

INFORMAÇÕES ADICIONAIS

POTÊNCIA	FLUXO LUMINOSO [lm]
7 W	450

**UGR** <16    **CRI** >90    3-SDCM    100-240V    **IP** 20

CONTROLE

TRIAC Dimm   

AJUSTES

360°    0 - 30°

CORES

ANTIOFUSCANTE

DISTRIBUIÇÃO DE LUZ

15°    24°    38°

APLICAÇÃO

DESENHOS TÉCNICOS

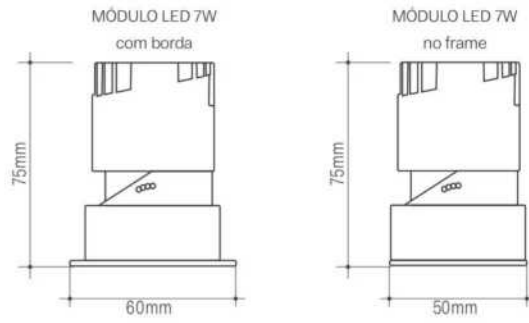

CURVAS FOTOMÉTRICAS

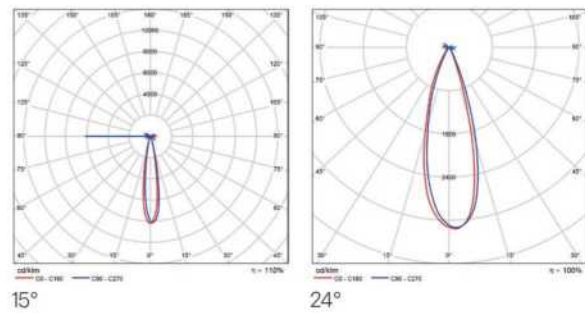





# TINY

Luminária tecnológica, com um sistema de lente patenteado que possui dimensões reduzidas e um surpreendente desempenho. O equilíbrio entre minimalismo e conforto visual.



## INFORMAÇÕES GERAIS

Luminária em alumínio injetado



 2700K

CRI  
>90

 3-SDCM

 100-240V

 Dimerizável

 50 000 h

 598 lm

# Tecnologia

A Tiny foi projetada com o propósito de oferecer alto desempenho com dimensões reduzidas e um controle de ofuscamento apurado.

O conjunto óptico foi desenvolvido para que a projeção da luz ocorra abaixo da luminária, como representado na imagem. A ausência de brilho no corpo da luminária é notória.



## INFORMAÇÕES ADICIONAIS

POTÊNCIA	FLUXO LUMINOSO [lm]
8,4 W	598

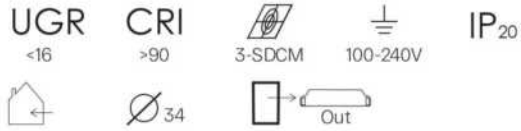

## CONTROLE



## CORES



## ANTIOFUSCANTE



## DISTRIBUIÇÃO DE LUZ



## APLICAÇÃO



## DESENHOS TÉCNICOS

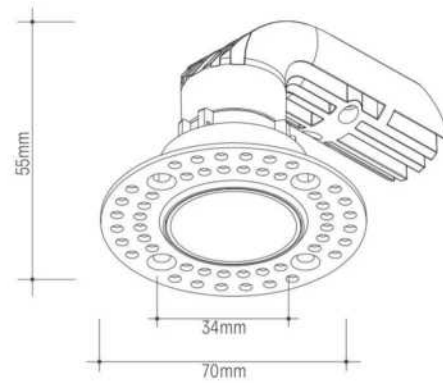

## CURVAS FOTOMÉTRICAS

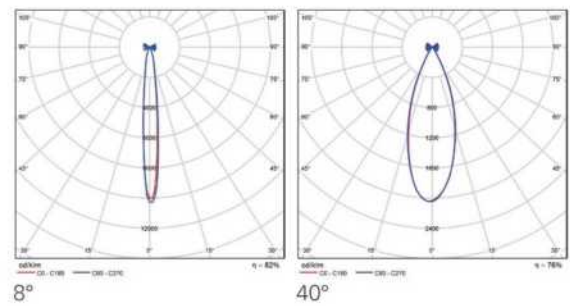



# MINI ONNE

Mini embutido com borda, orientável e antiofuscante preto fosco. Luminária discreta para luz de destaque.



INFORMAÇÕES GERAIS

Luminária em alumínio injetado

 2700K / 3000K

CRI  >90  3-SDCM  220-240V

 50 000 h

 275 lm

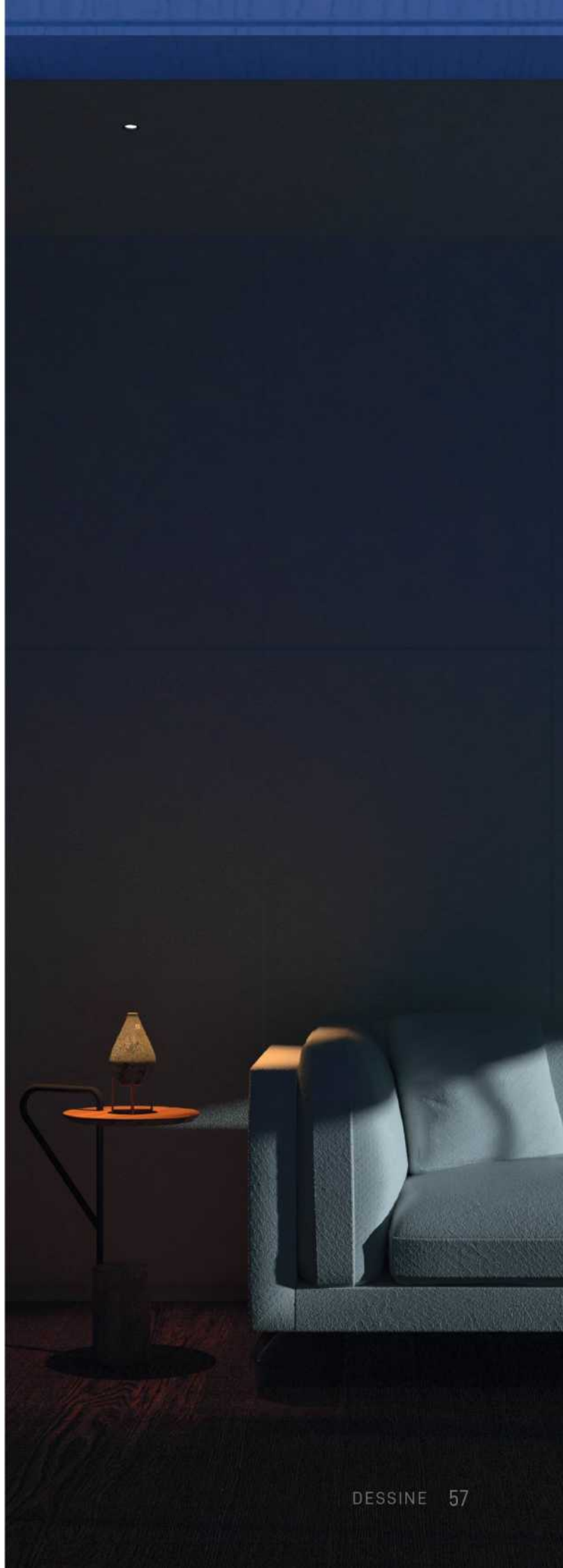

INFORMAÇÕES ADICIONAIS

POTÊNCIA	FLUXO LUMINOSO [lm]
5 W	275

UGR <16    CRI >90    3-SDCM    220-240V    IP<sub>20</sub>

CONTROLE



AJUSTES



CORES



ANTIOFUSCANTE



DISTRIBUIÇÃO DE LUZ



APLICAÇÃO



DESENHOS TÉCNICOS

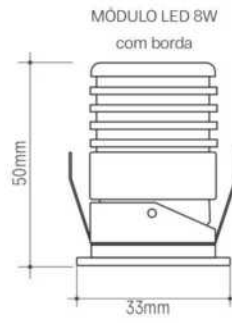

CURVAS FOTOMÉTRICAS

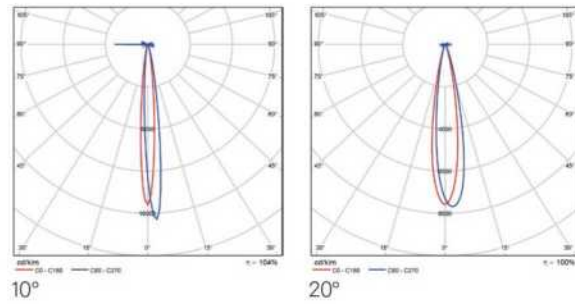





# GRACE

Refinada e elegante, Grace se adapta a qualquer estilo, do clássico ao contemporâneo. Luminária no frame com LED integrado que possui excelente controle de ofuscamento,  $Ra > 90$  e  $SDCM < 3$ .



#### INFORMAÇÕES GERAIS

Luminária em alumínio injetado



 2700K / 3000K

CRI  
>90

 3-SDCM

 100-240V

 Dimerizável

 50 000 h

 600 lm / 900 lm

## INFORMAÇÕES ADICIONAIS

POTÊNCIA	FLUXO LUMINOSO [lm]
8 W	600
12 W	900

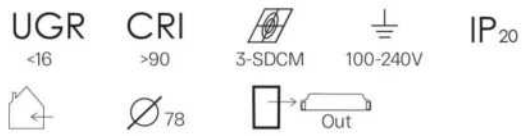

## CONTROLE



## AJUSTES



## CORES



## ANTIOFUSCANTE



## DISTRIBUIÇÃO DE LUZ



## APLICAÇÃO



## DESENHOS TÉCNICOS

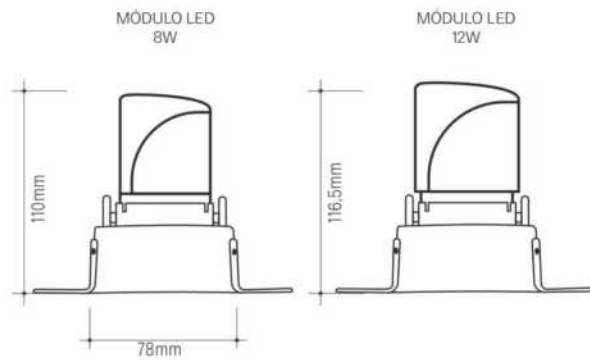

## CURVAS FOTOMÉTRICAS

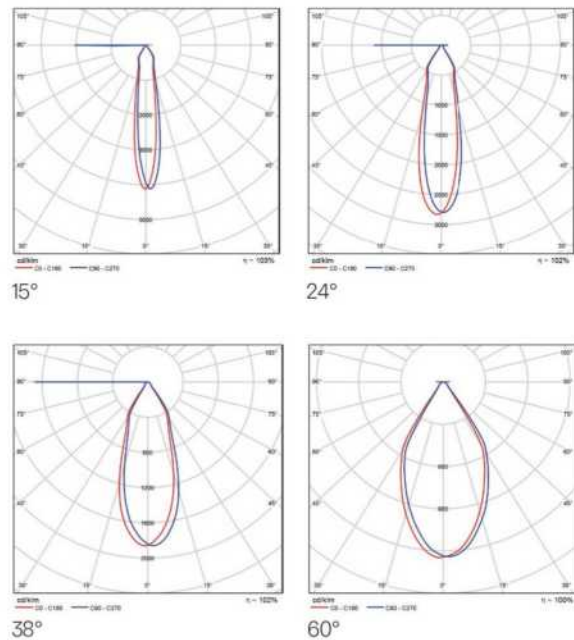





# OSLO

Embutir

Luminária multifocos dark light com o melhor desempenho do mercado e o menor grau de ofuscamento. LED integrado com  $Ra > 90$  e  $SDCM < 3$ .





Versão  
No frame preto



Versão  
Com borda branco

#### INFORMAÇÕES GERAIS

Luminária em alumínio injetado

 2700K / 3000K

CRI  
>80/90

 3-SDCM

 100-240V

 Dimerizável

 50 000 h

 540 lm / 1120 lm

## INFORMAÇÕES ADICIONAIS

POTÊNCIA		FLUXO LUMINOSO [lm]
5 W	3 focos	540
10 W	6 focos	1120

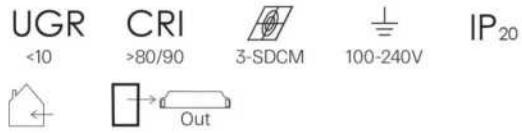

## DESENHOS TÉCNICOS

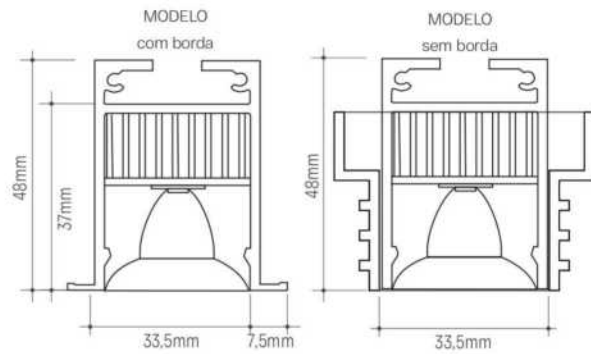

## CONTROLE



## CURVAS FOTOMÉTRICAS

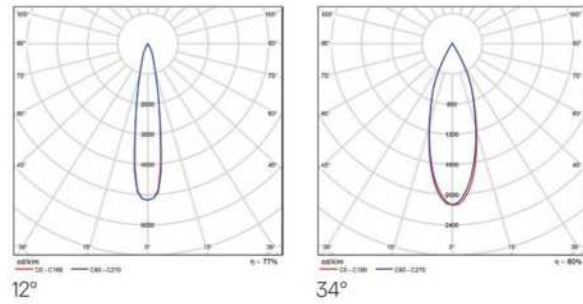

## CORES

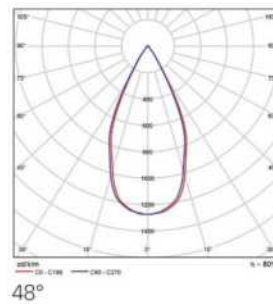

## ANTIOFUSCANTE



## DISTRIBUIÇÃO DE LUZ



## APLICAÇÃO







# SIMME

Luminária prática com pequena borda e LED recuado, que proporciona um excelente conforto visual. LED integrado com  $Ra > 90$  e  $SDCM < 3$ .



#### INFORMAÇÕES GERAIS

Luminária em alumínio injetado

 2700K / 3000K

CRI  
>90

 3-SDCM

 100-240V

 Dimerizável

 50 000 h

 600 lm / 900 lm

INFORMAÇÕES ADICIONAIS

POTÊNCIA	FLUXO LUMINOSO [lm]
8 W	600
12 W	900

**UGR** <16    **CRI** >90    3-SDCM    100-240V    **IP**<sub>20</sub>

DESENHOS TÉCNICOS

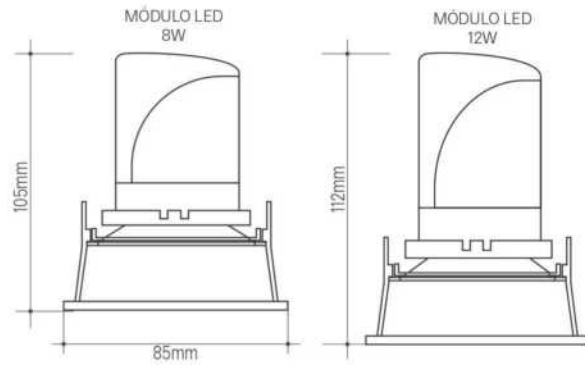

CONTROLE

**TRIAC Dimm**

AJUSTES

360°    0 - 30°

CORES



CURVAS FOTOMÉTRICAS

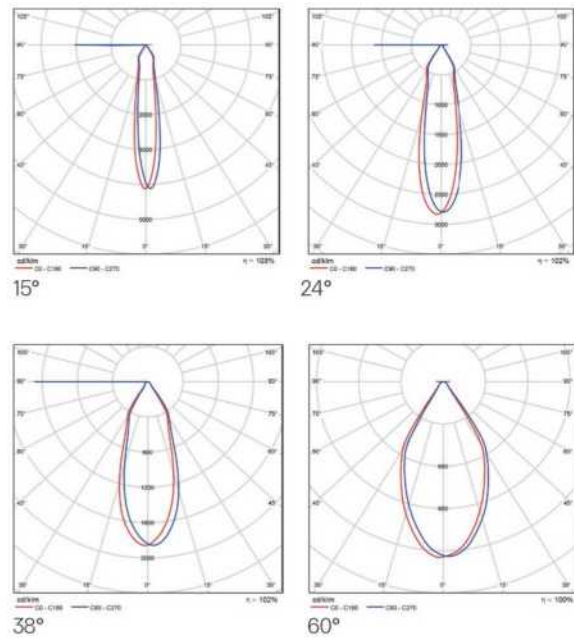

DISTRIBUIÇÃO DE LUZ



APLICAÇÃO







# BEAN

Embutido versátil que possibilita ajuste do ângulo da luz do foco fechado ao foco aberto. LED integrado com  $Ra > 90$  e  $SDCM < 3$ .



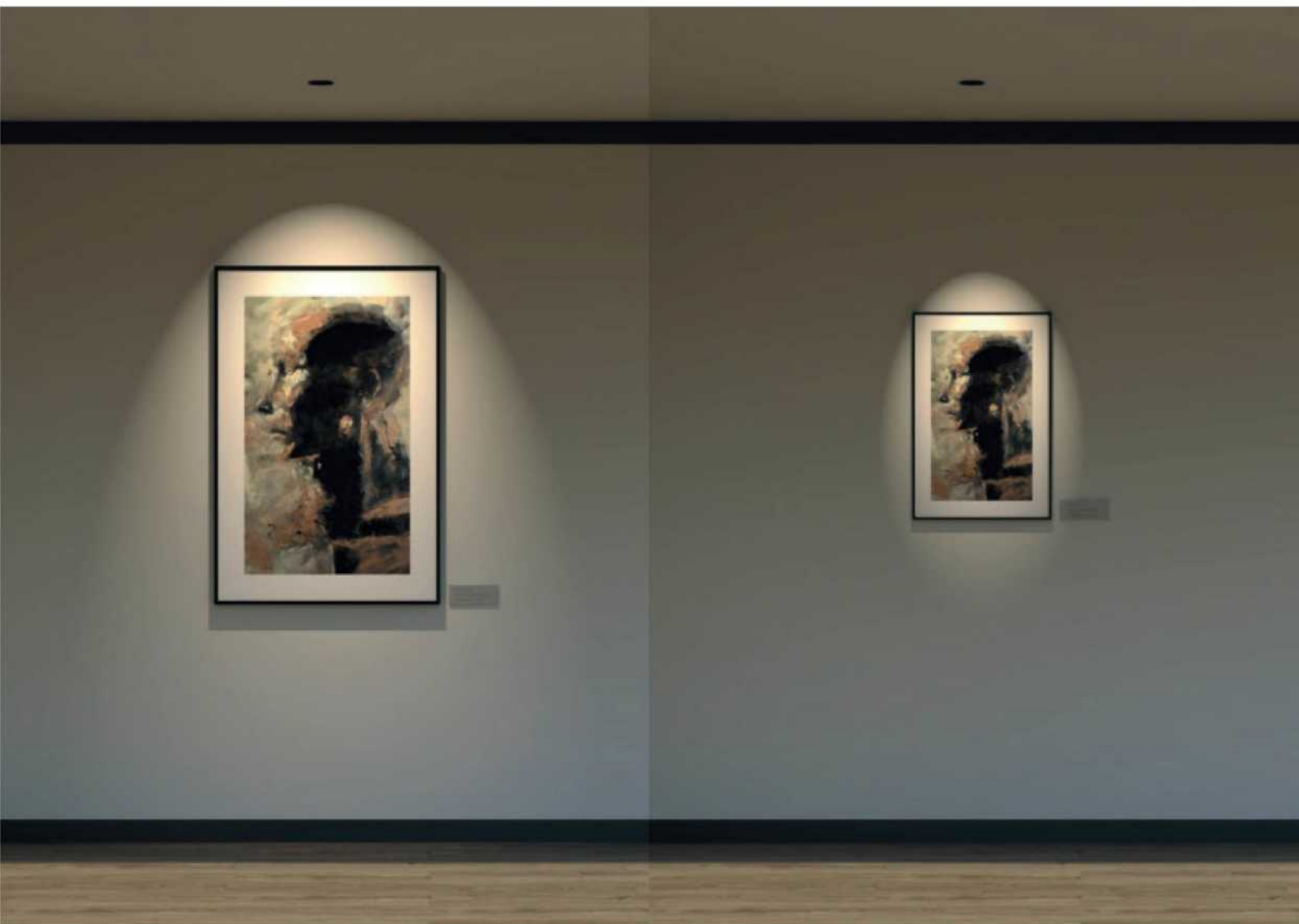

#### INFORMAÇÕES GERAIS

Luminária em alumínio injetado

 2700K / 3000K

CRI  
>90

 3-SDCM

 220-240V

 Dimerizável

 50 000 h

 500 lm



# Versatilidade

Bean possui ajuste preciso do conjunto óptico, sendo assim a mesma luminária é capaz de oferecer tanto ângulos fechados para destaque, quanto ângulos abertos variando o fecho de luz de 15° a 60°



Grau Aberto



Grau Fechado

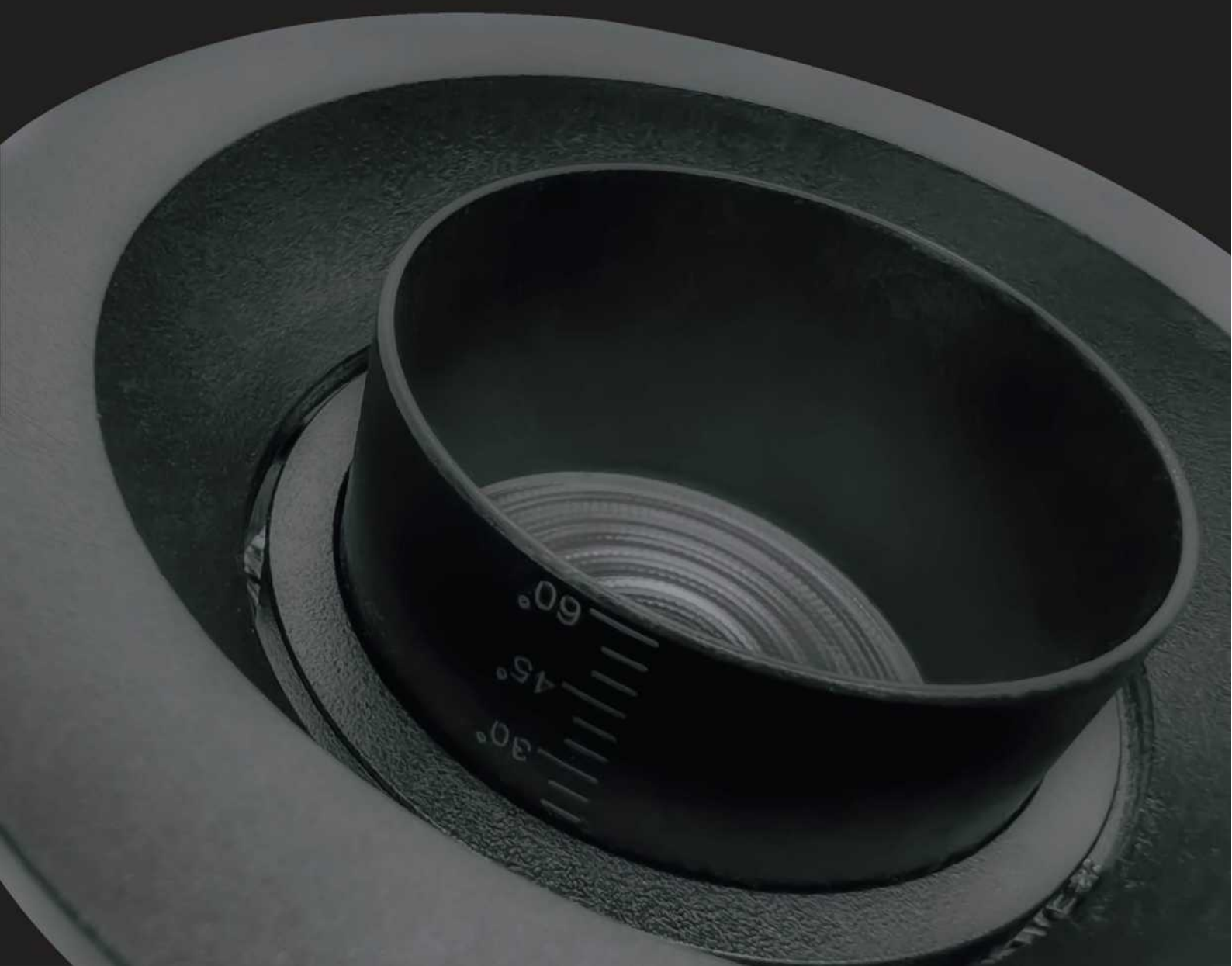

## INFORMAÇÕES ADICIONAIS

POTÊNCIA	FLUXO LUMINOSO [lm]
7 W	500

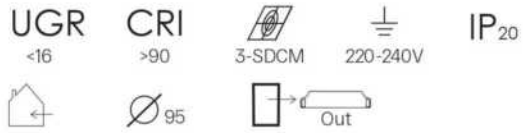

## CONTROLE



## AJUSTES



## CORES



## ANTIOFUSCANTE



## DISTRIBUIÇÃO DE LUZ



## APLICAÇÃO



## DESENHOS TÉCNICOS

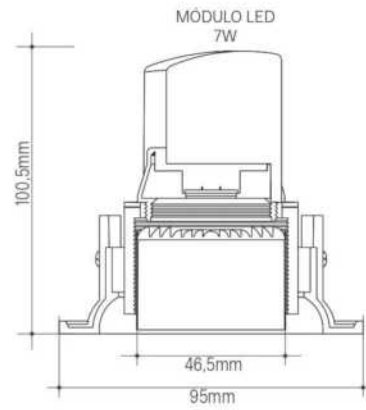

## CURVAS FOTOMÉTRICAS

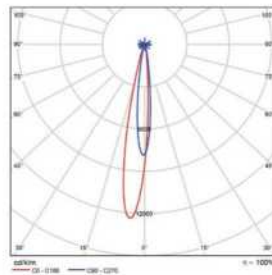



# BOWL

Luminária em LED integrado delicada com pequena dimensão para efeito de luz difusa.



#### INFORMAÇÕES GERAIS

Luminária em alumínio injetado

 3000K

CRI  
>90

 3-SDCM

 100-240V

 50 000 h

 850 lm



## INFORMAÇÕES ADICIONAIS

POTÊNCIA	FLUXO LUMINOSO [lm]
18 W	850

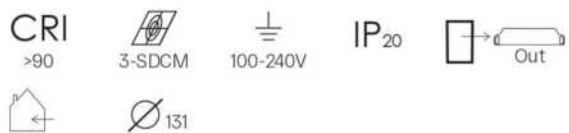

## CONTROLE



## CORES



## DISTRIBUIÇÃO DE LUZ



## APLICAÇÃO



## DESENHOS TÉCNICOS

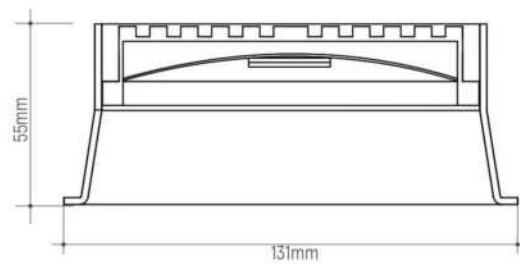

## CURVAS FOTOMÉTRICAS

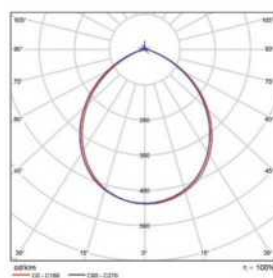





# SIMPLE

Luminária em LED integrado com excelente fluxo luminoso para efeito de luz difusa.





#### INFORMAÇÕES GERAIS

Luminária em alumínio injetado

 3000K

CRI  
>90

 3-SDCM

 100-240V

 50 000 h

 2830 lm

## INFORMAÇÕES ADICIONAIS

POTÊNCIA	FLUXO LUMINOSO [lm]
25 W	2830

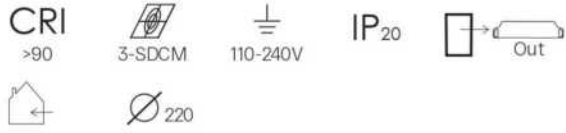

## CONTROLE



## CORES



## DISTRIBUIÇÃO DE LUZ



## APLICAÇÃO



## DESENHOS TÉCNICOS

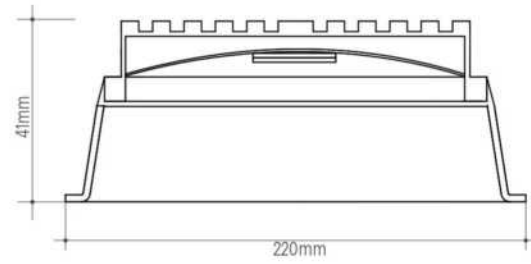

## CURVAS FOTOMÉTRICAS

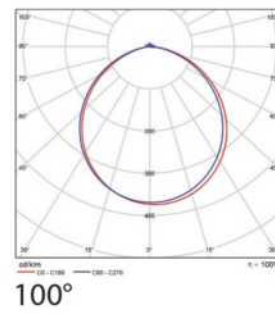





# ALPHA

Luminária discreta e eficiente para ambientes corporativos e residenciais. Sua principal qualidade é um surpreendente controle do nível de ofuscamento, priorizando o conforto visual.

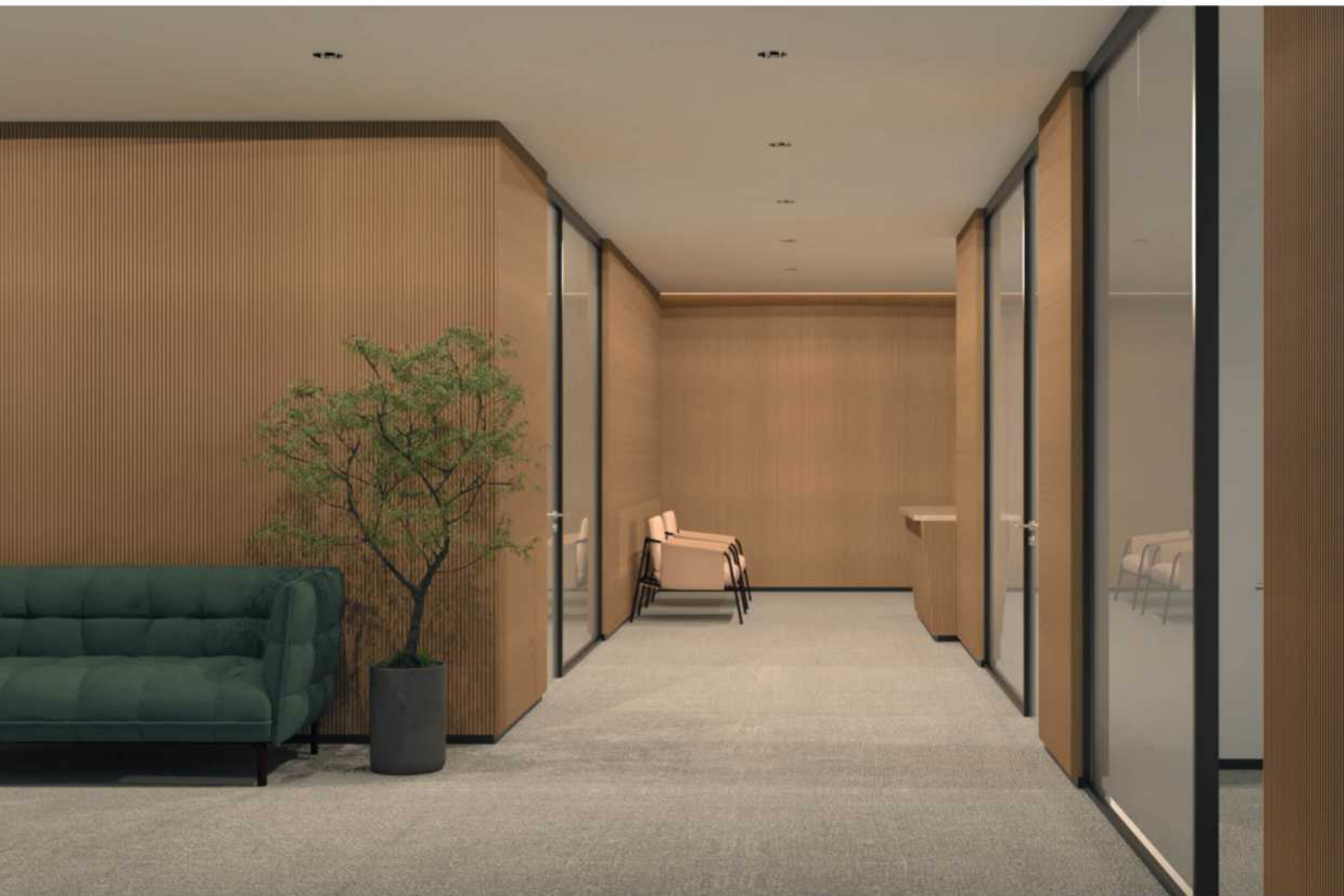

Versão  
No frame



Versão  
Com borda

#### INFORMAÇÕES GERAIS

Luminária em alumínio injetado

 2700K / 3000K

CRI  
>90

 3-SDCM

 100-240V





 Dimerizável

 50 000 h

 1333 lm

INFORMAÇÕES ADICIONAIS

POTÊNCIA	FLUXO LUMINOSO [lm]
13 W	1333

**UGR** <16    **CRI** >90    3-SDCM    100-240V    **IP**<sub>20</sub>  
         → 

CONTROLE



CORES



ANTIOFUSCANTE



DISTRIBUIÇÃO DE LUZ



APLICAÇÃO



DESENHOS TÉCNICOS

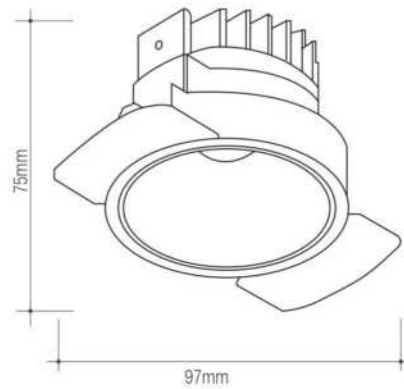
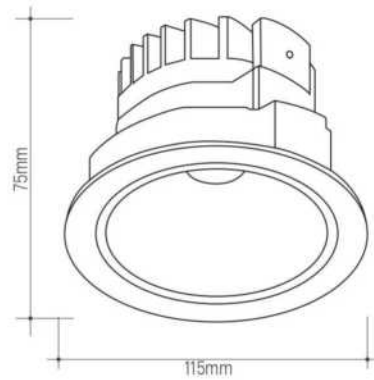

CURVAS FOTOMÉTRICAS

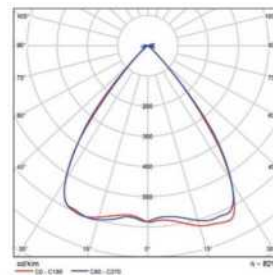

100°





# DELTA

Luminária para ambientes residenciais e corporativos que oferece luz difusa com alto nível de controle de ofuscamento priorizando o conforto visual.





#### INFORMAÇÕES GERAIS

Luminária em alumínio injetado

 2700K / 3000K

CRI  
>90

 3-SDCM

 100-240V

 Dimerizável



 50 000 h

 1250 lm / 2250 lm



INFORMAÇÕES ADICIONAIS

POTÊNCIA	FLUXO LUMINOSO [lm]
15 W	1250
25 W	2250

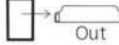
**UGR** <10    **CRI** >90    3-SDCM    100-240V    **IP**<sub>20</sub>  
        

CONTROLE



CORES



ANTIOFUSCANTE



DISTRIBUIÇÃO DE LUZ



CURVAS FOTOMÉTRICAS

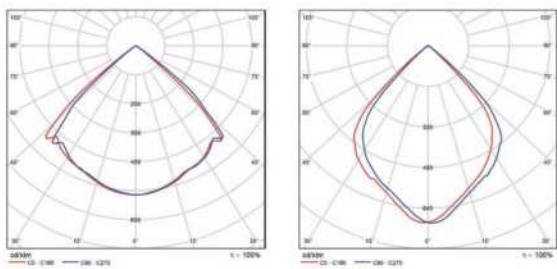

APLICAÇÃO



DESENHOS TÉCNICOS

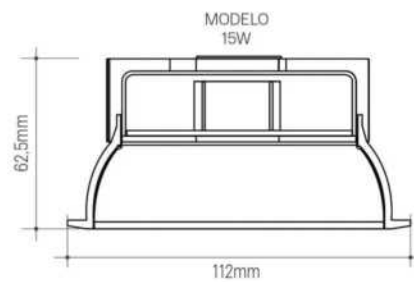
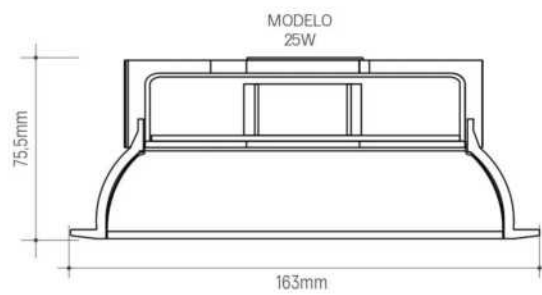





# VICK

Luminária de foco com LED integrado e excelente controle de ofuscamento. Ra>90 e SDCM<3.



#### INFORMAÇÕES GERAIS

Luminária em alumínio injetado

 2700K / 3000K

CRI  
>90

 3-SDCM

 100-240V

 Dimerizável

 50 000 h

 803 lm



## INFORMAÇÕES ADICIONAIS

POTÊNCIA	FLUXO LUMINOSO [lm]
10 W	803
7 W	560

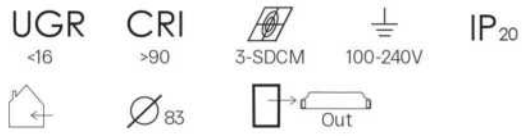

## CONTROLE



## AJUSTES



## CORES



## ANTIOFUSCANTE



## DISTRIBUIÇÃO DE LUZ



## APLICAÇÃO



## DESENHOS TÉCNICOS

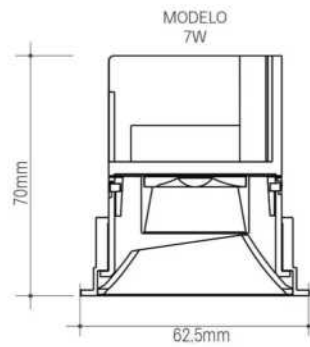
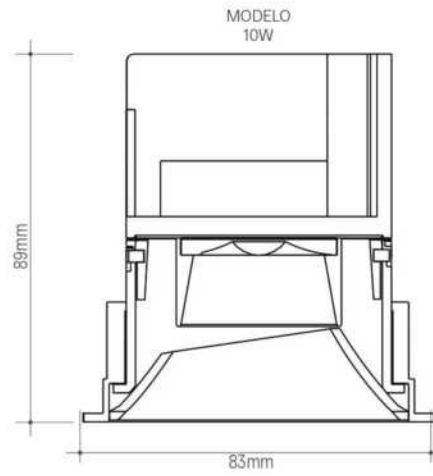

## CURVAS FOTOMÉTRICAS

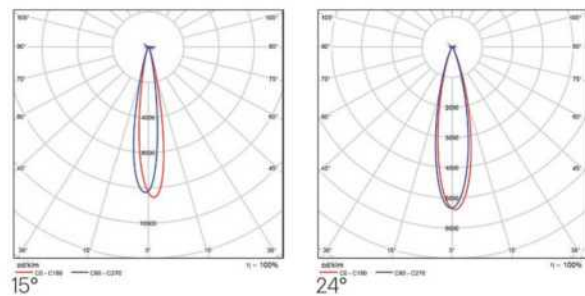





# VICK

## WALLWASHER

Luminária wallwasher para uma iluminação uniforme em parede, minimizando as sombras e realçando a textura da superfície. Possui LED integrado excelente controle de ofuscamento.  $Ra > 90$  e  $SDCM < 3$ .





#### INFORMAÇÕES GERAIS

Luminária em alumínio injetado

 2700K / 3000K

CRI  
>90

 3-SDCM

 100-240V

 Dimerizável

 50 000 h



 532 lm



## INFORMAÇÕES ADICIONAIS

POTÊNCIA	FLUXO LUMINOSO [lm]
12 W	532

UGR <16    CRI >90    3-SDCM    100-240V    IP<sub>20</sub>

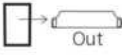
## DESENHOS TÉCNICOS

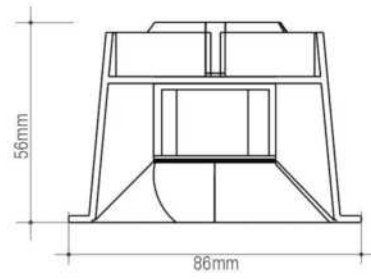

## CONTROLE



## CURVAS FOTOMÉTRICAS

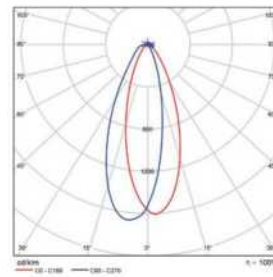

## CORES



## ANTIOFUSCANTE



## DISTRIBUIÇÃO DE LUZ



## APLICAÇÃO

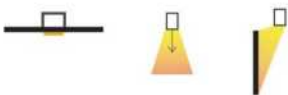





# VICK LT

Luminária da linha Vick, com suas características de praticidade e eficiência para unidades residenciais.

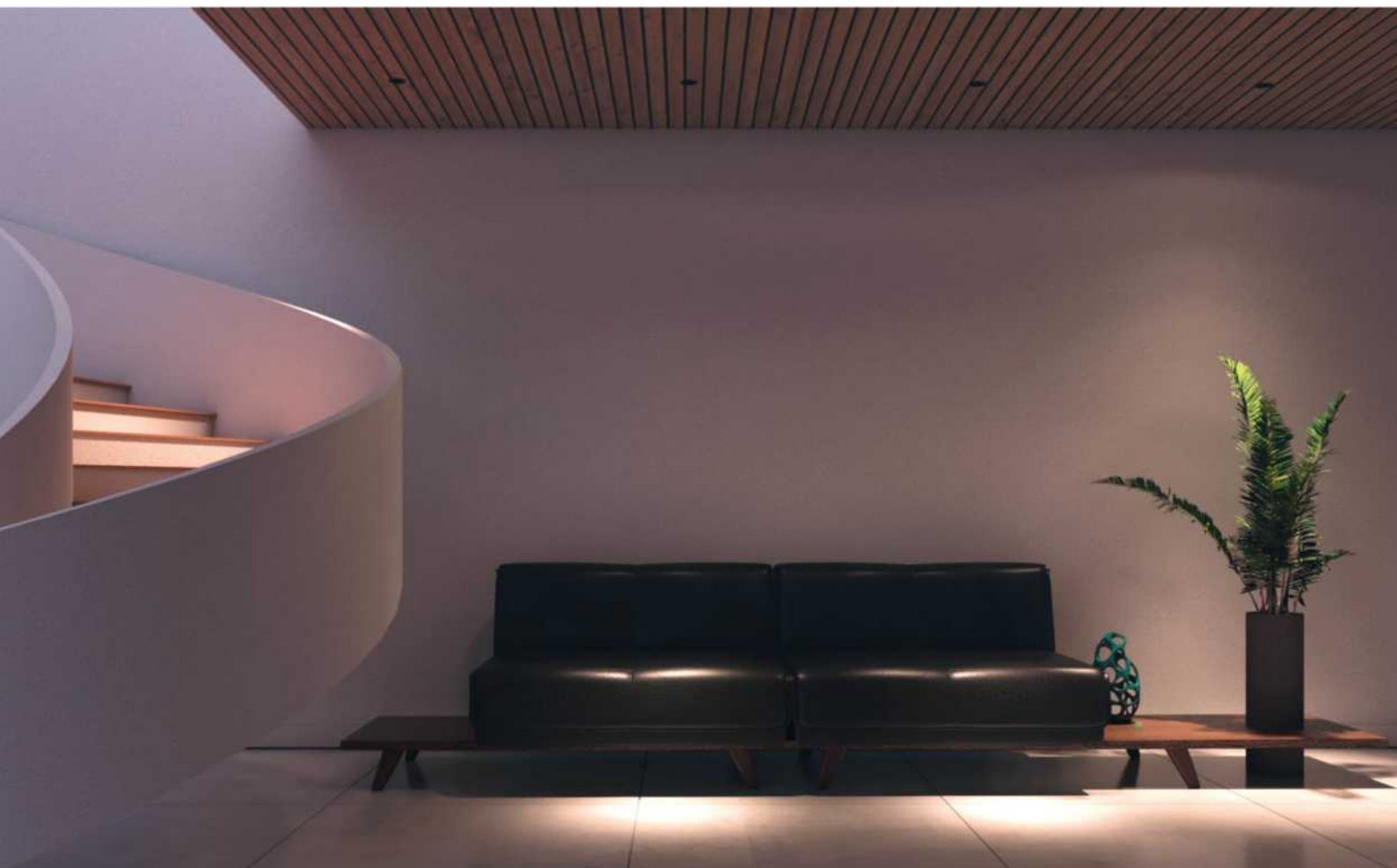

## INFORMAÇÕES GERAIS

Luminária em alumínio injetado

 2700K / 3000K

CRI  
>90

 3-SDCM

 100-240V

 Dimerizável



 50 000 h

 428 lm



INFORMAÇÕES ADICIONAIS

POTÊNCIA	FLUXO LUMINOSO [lm]
7W	428

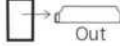
**UGR** <16    **CRI** >90    3-SDCM    100-240V    **IP** 20  
     82,5     Out

CONTROLE

 TRIAC Dimm    

AJUSTES

 360°     0 - 25°

CORES



ANTIOFUSCANTE



DISTRIBUIÇÃO DE LUZ



APLICAÇÃO

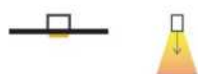

DESENHOS TÉCNICOS

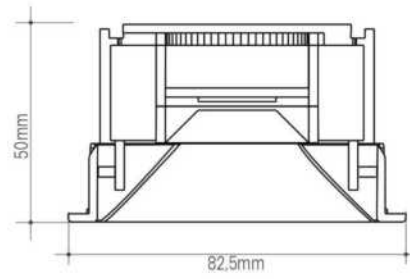

CURVAS FOTOMÉTRICAS

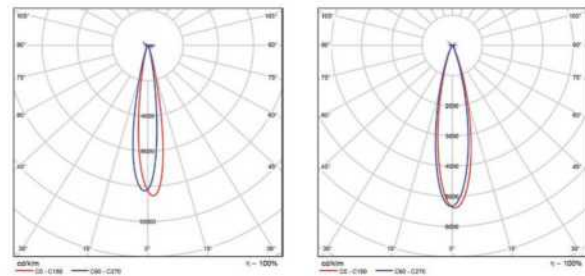

15°

24°





# VICK

## SQUARE

Luminária quadrada de foco com LED integrado e excelente controle de ofuscamento. Ra>90 e SDCM<3.



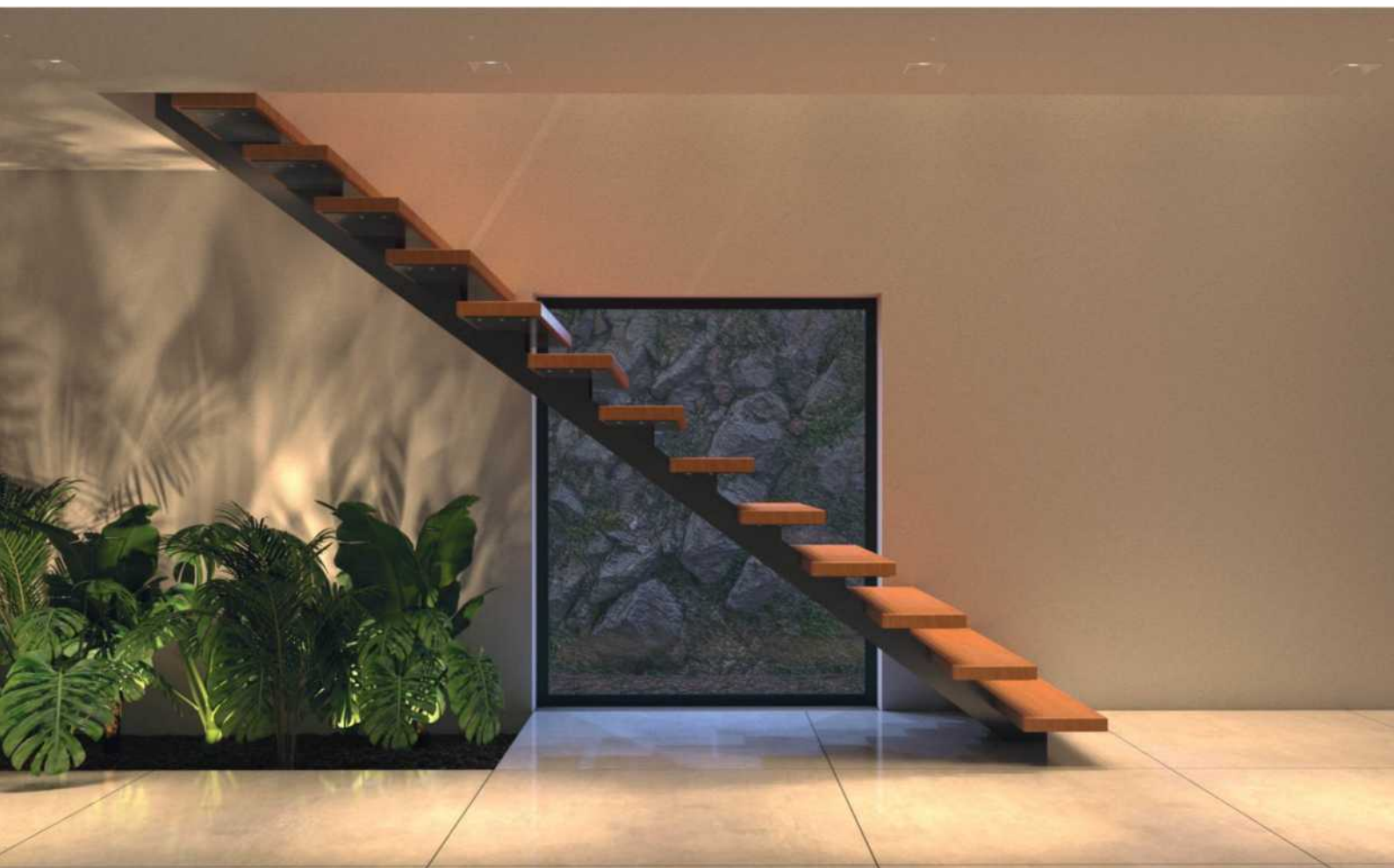

#### INFORMAÇÕES GERAIS



Luminária em alumínio injetado

 2700K / 3000K

CRI  
>90

 3-SDCM

 100-240V

 Dimerizável

 50 000 h

 885 lm

INFORMAÇÕES ADICIONAIS

POTÊNCIA	FLUXO LUMINOSO [lm]
12 W	885

**UGR** <16    **CRI** >90    3-SDCM    100-240V    **IP**<sub>20</sub>

   → Out

CONTROLE

**TRIAC Dimm**

AJUSTES

360°    0 - 30°

CORES



ANTIOFUSCANTE



DISTRIBUIÇÃO DE LUZ



APLICAÇÃO



DESENHOS TÉCNICOS

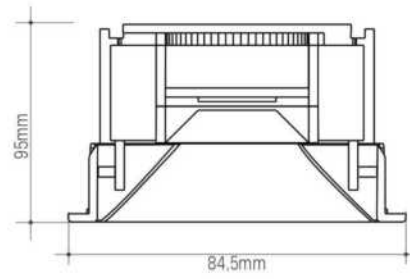

CURVAS FOTOMÉTRICAS

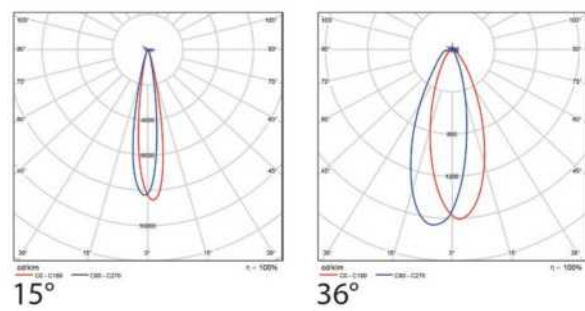





# VAN

Luminária técnica decorativa com altura ajustável e acabamento no frame para ambientes residenciais e corporativos.



#### INFORMAÇÕES GERAIS

Luminária em alumínio injetado

 2700K

CRI  
>90

 3-SDCM

 100-277V

 Dimerizável

 50 000 h

 640 lm

INFORMAÇÕES ADICIONAIS

POTÊNCIA	FLUXO LUMINOSO [lm]
9,7 W	640

**UGR** <16    **CRI** >90    3-SDCM    100-277V    **IP**<sub>20</sub>

CONTROLE



AJUSTES



CORES



DISTRIBUIÇÃO DE LUZ



APLICAÇÃO



DESENHOS TÉCNICOS

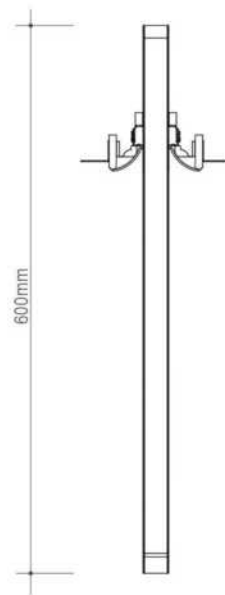

CURVAS FOTOMÉTRICAS

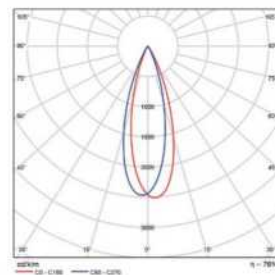

30°









EXTERNO



# UNDER

COMB

Luminária de alto padrão com acabamento inox para exterior com excelente controle de ofuscamento.

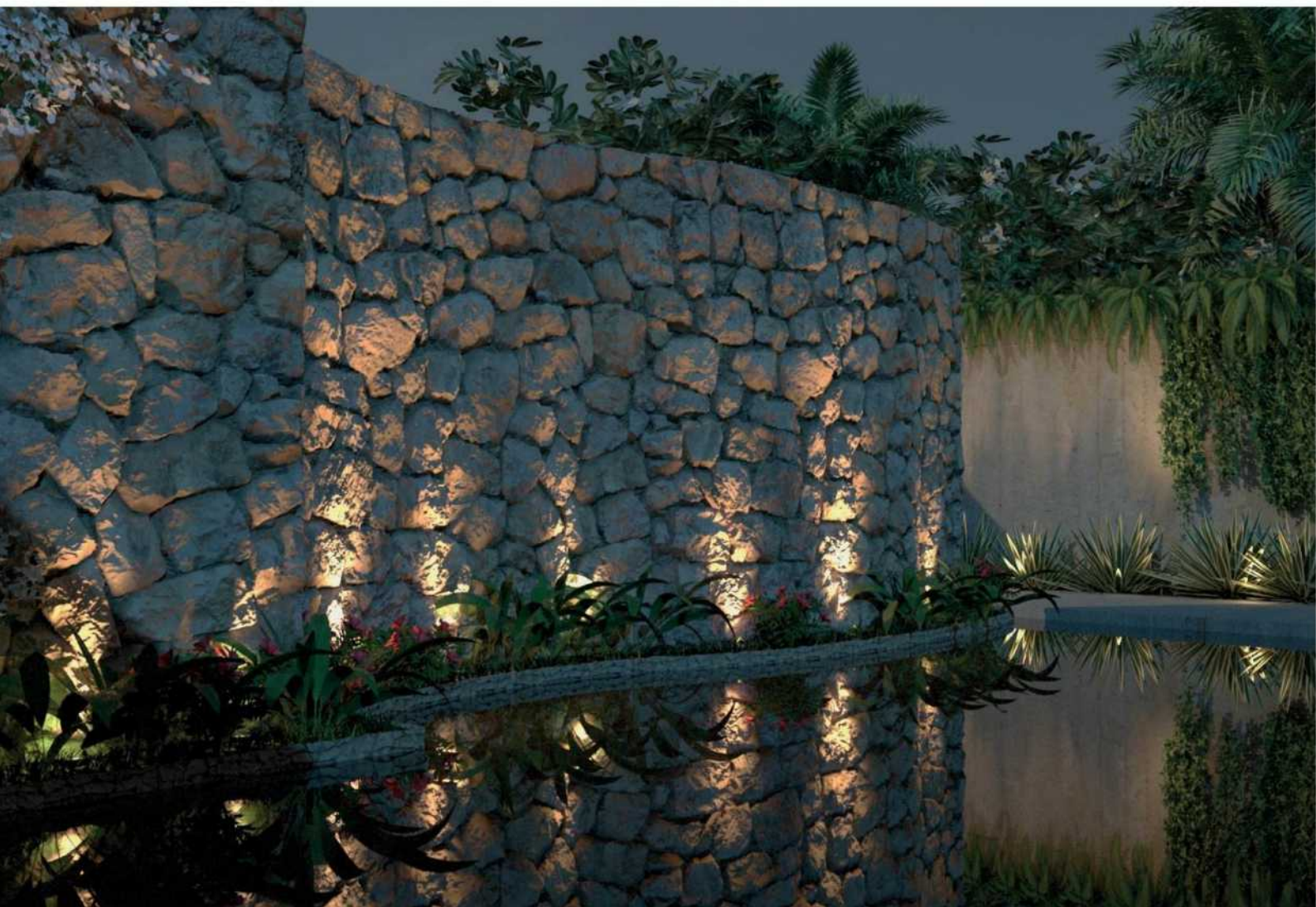

#### INFORMAÇÕES GERAIS



Luminária em alumínio injetado

 3000K

CRI  
>90

 3-SDCM

DC - 24V

 Dimerizável



 50 000 h

 654 lm

INFORMAÇÕES ADICIONAIS

POTÊNCIA	FLUXO LUMINOSO [lm]
7,7 W	654

UGR <16    CRI >90    3-SDCM    DC - 24V    IP<sub>67</sub>

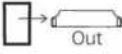
CONTROLE



CORES



DISTRIBUIÇÃO DE LUZ



APLICAÇÃO



DESENHOS TÉCNICOS

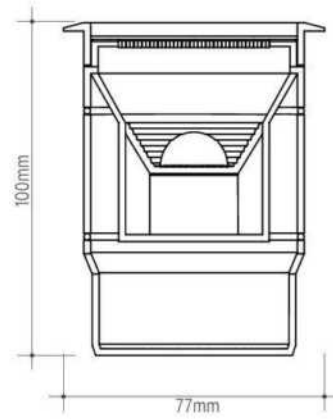

CURVAS FOTOMÉTRICAS

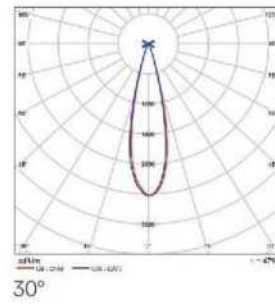





# UNDER

## WALLWASHER

Luminária de alto padrão com acabamento inox para exterior com tecnologia wallwasher para uma iluminação uniforme em parede, minimizando sombras e realçando a textura da superfície.



#### INFORMAÇÕES GERAIS

Luminária em alumínio injetado

 3000K

CRI  
>90

 3-SDCM

DC - 24V

 Dimerizável

 50 000 h

 602 lm

## INFORMAÇÕES ADICIONAIS

POTÊNCIA	FLUXO LUMINOSO (lm)
92 W	602

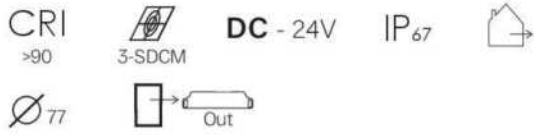

## CONTROLE



## CORES



## DISTRIBUIÇÃO DE LUZ



## APLICAÇÃO

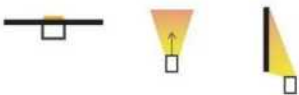

## DESENHOS TÉCNICOS

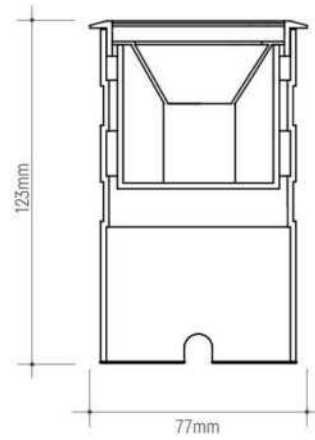

## CURVAS FOTOMÉTRICAS

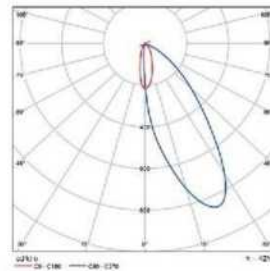







# UNDER

## MINI

Luminária de alto padrão para exterior com acabamento inox e um excelente controle de ofuscamento.

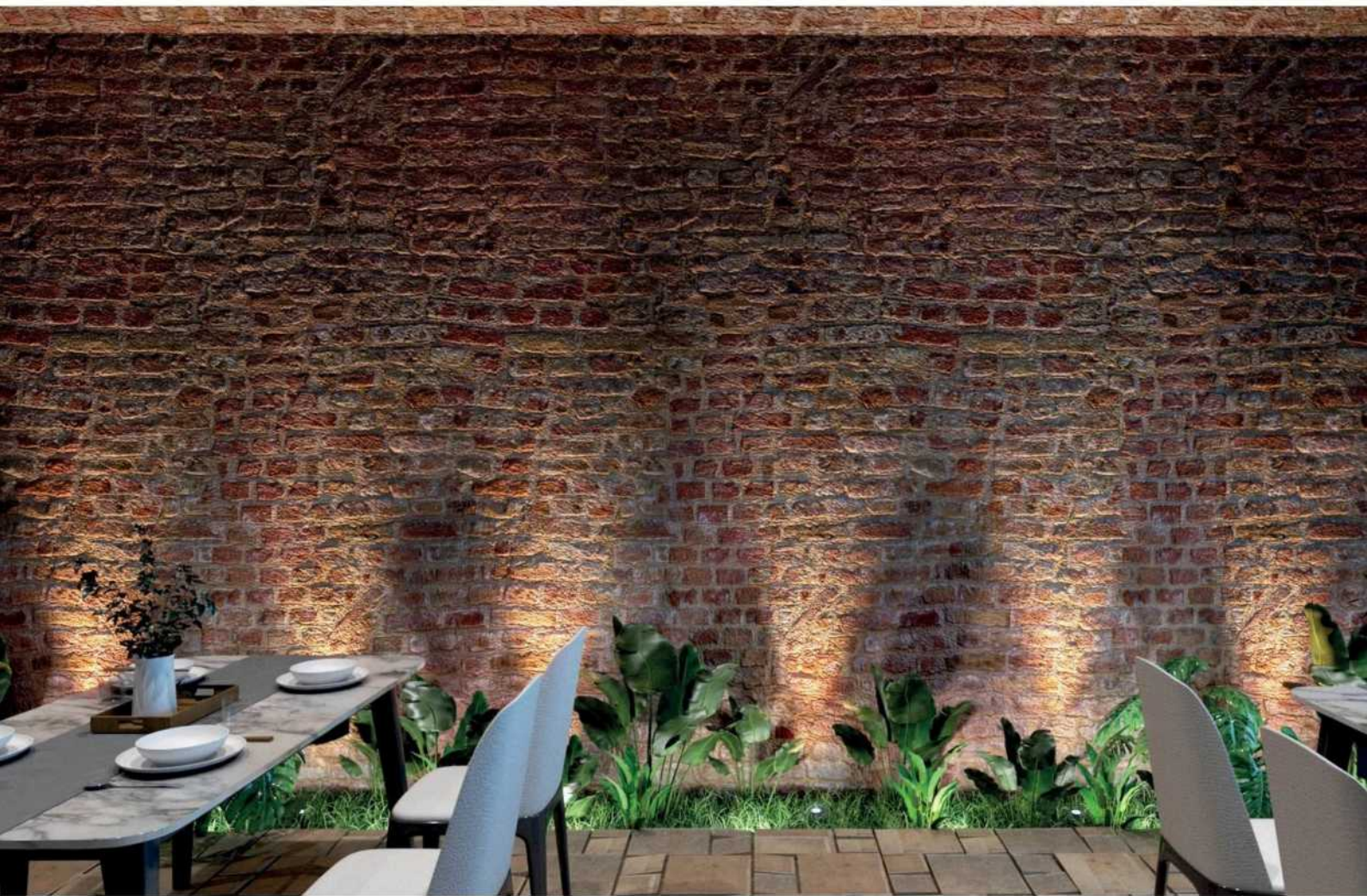

#### INFORMAÇÕES GERAIS



Luminária em alumínio injetado

 3000K

CRI  
>90

 3-SDCM

DC - 24V

 Dimerizável



 50 000 h

 253 lm

## INFORMAÇÕES ADICIONAIS

POTÊNCIA	FLUXO LUMINOSO (lm)
5W	253

UGR <16    CRI >90    3-SDCM    DC - 24V    IP<sub>67</sub>

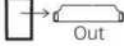
## CONTROLE



## CORES



## DISTRIBUIÇÃO DE LUZ



## APLICAÇÃO



## DESENHOS TÉCNICOS

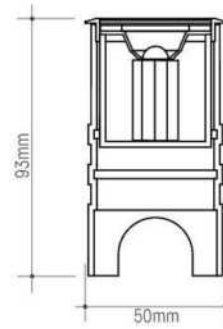

## CURVAS FOTOMÉTRICAS

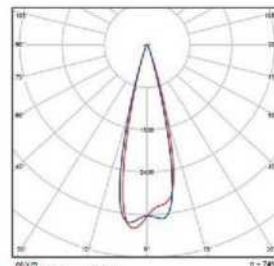

24°





# UNDER MICRO

Luminária de alto padrão para exterior com acabamento inox e dimensões reduzidas, delicada e minimalista.

## INFORMAÇÕES GERAIS

Luminária em alumínio injetado

 3000K

CRI  
>90



DC - 24V



Dimerizável

 50 000 h

 141 lm



## DESENHOS TÉCNICOS

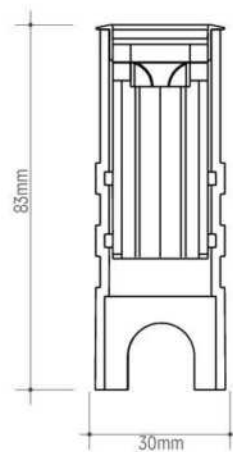

## INFORMAÇÕES ADICIONAIS

POTÊNCIA	FLUXO LUMINOSO [lm]
3W	141

UGR  
<16

CRI  
>90



DC - 24V

IP<sub>67</sub>

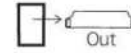

## CONTROLE



DALI

## CORES



## DISTRIBUIÇÃO DE LUZ



12°

## APLICAÇÃO



## CURVAS FOTOMÉTRICAS

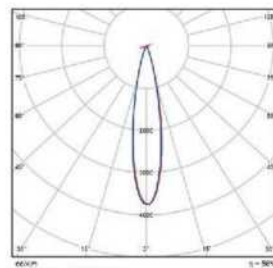

12°









# GROUND

Luminária de alto padrão para exterior com acabamento inox e um excelente controle de ofuscamento, indicada para iluminação de arquitetura e paisagismo



#### INFORMAÇÕES GERAIS



Luminária em alumínio injetado

 3000K / 4000K

CRI  
>90

 3-SDCM

 220-240V

 50 000 h

 1446 lm / 2371 lm

## INFORMAÇÕES ADICIONAIS

POTÊNCIA		FLUXO LUMINOSO (lm)
12 W	19° e 30°	1446
18 W	15° e 38°	2371

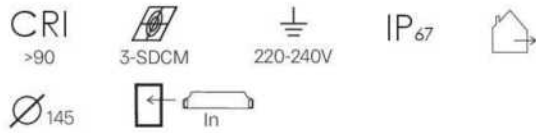

## CONTROLE



## AJUSTES

\*Para modelo 18W



## CORES



## DISTRIBUIÇÃO DE LUZ



## APLICAÇÃO



## DESENHOS TÉCNICOS

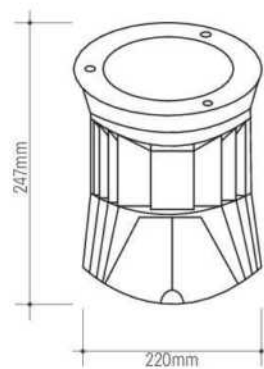
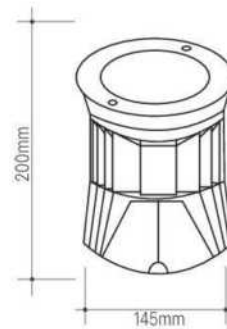

## CURVAS FOTOMÉTRICAS

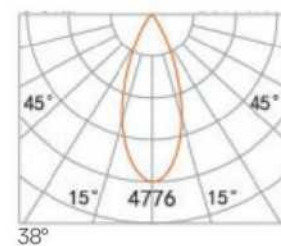
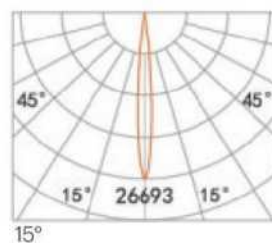
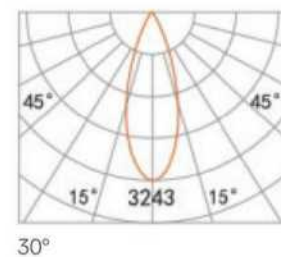
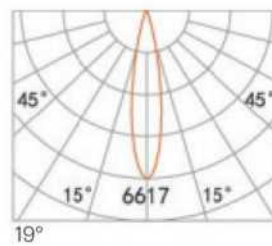





# TULIP

Luminária com acabamento inox para compor iluminação em jardins internos e externos, com luz suave e agradável.

## INFORMAÇÕES GERAIS

Luminária em inox

 3000K

CRI  >90     3-SDCM    DC - 24V     Dimerizável

 50 000 h

 159 lm

## DESENHOS TÉCNICOS

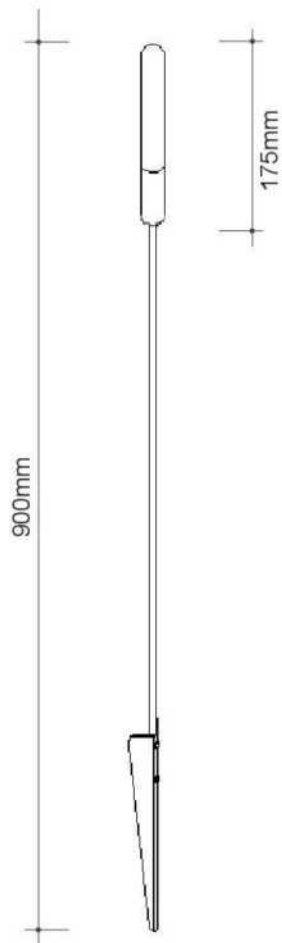

## INFORMAÇÕES ADICIONAIS

POTÊNCIA	FLUXO LUMINOSO [lm]
2W	159

CRI  >90     3-SDCM    DC - 24V    IP<sub>67</sub>    

∅ 25     Out

## CONTROLE



## CORES



## DISTRIBUIÇÃO DE LUZ



## APLICAÇÃO



## CURVAS FOTOMÉTRICAS

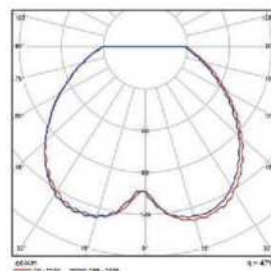











S O B R E P O R



# MOSS

Luminária minimalista com LED integrado. Moss possui excelente controle de ofuscamento e LED com  $Ra > 90$   $SDCM < 3$ .

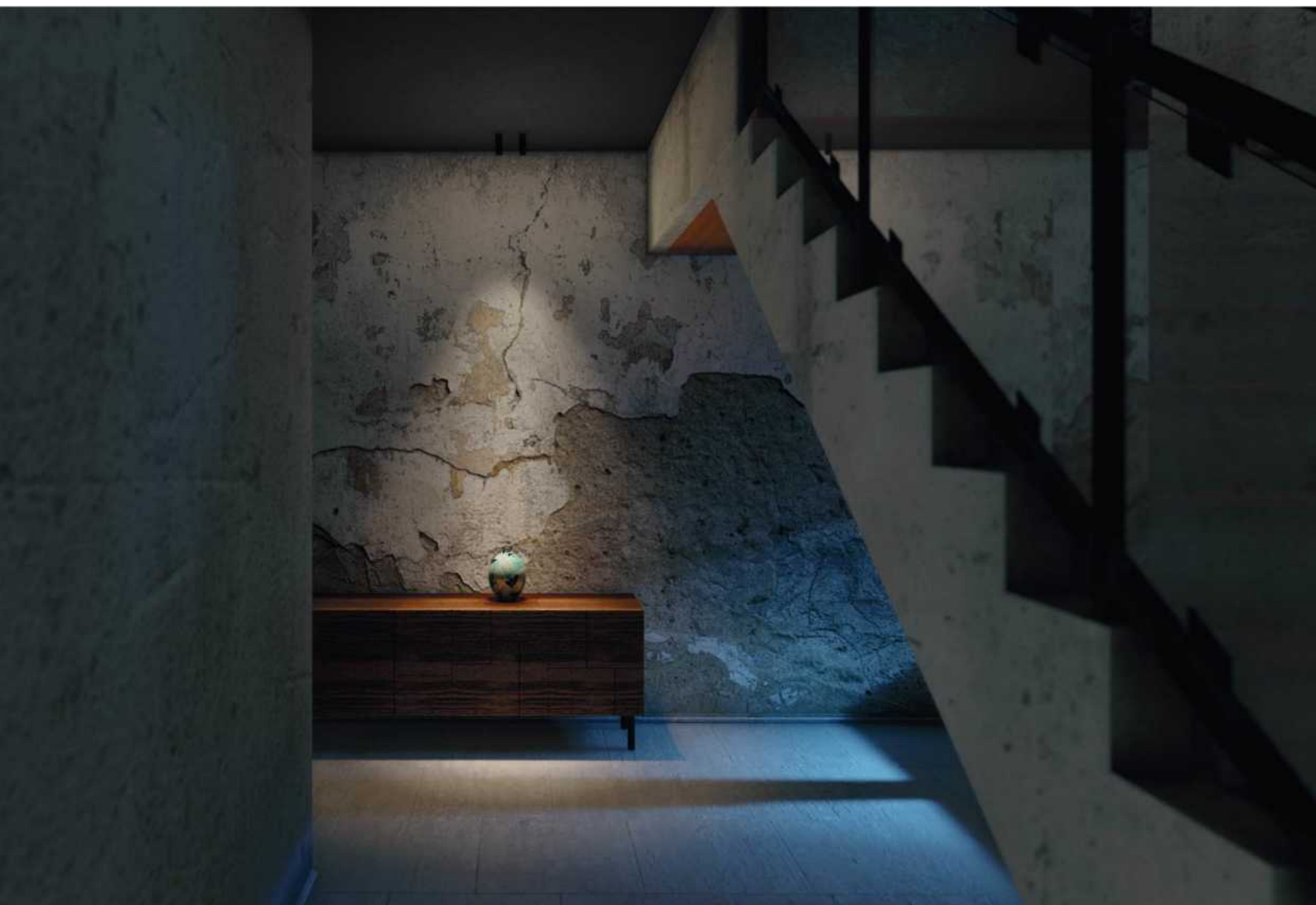

#### INFORMAÇÕES GERAIS



Luminária em alumínio injetado

 2700K / 3000K

CRI  >90  3-SDCM  220-240V

 50 000 h

 550 lm / 900 lm

## INFORMAÇÕES ADICIONAIS

POTÊNCIA	FLUXO LUMINOSO [lm]
7W	550
12W	900

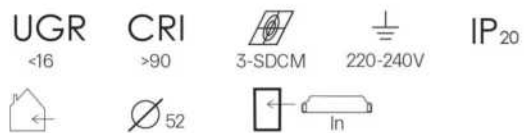

## CONTROLE



## CORES



## ANTIOFUSCANTE



## DISTRIBUIÇÃO DE LUZ



## APLICAÇÃO



## DESENHOS TÉCNICOS

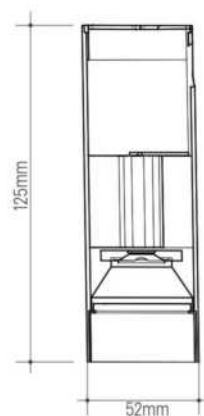

## CURVAS FOTOMÉTRICAS

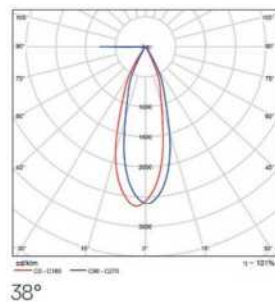





# OSLO

Luminária multifocos dark light com o melhor desempenho do mercado e o menor grau de ofuscamento. LED integrado com  $Ra > 90$  e  $SDCM < 3$ .



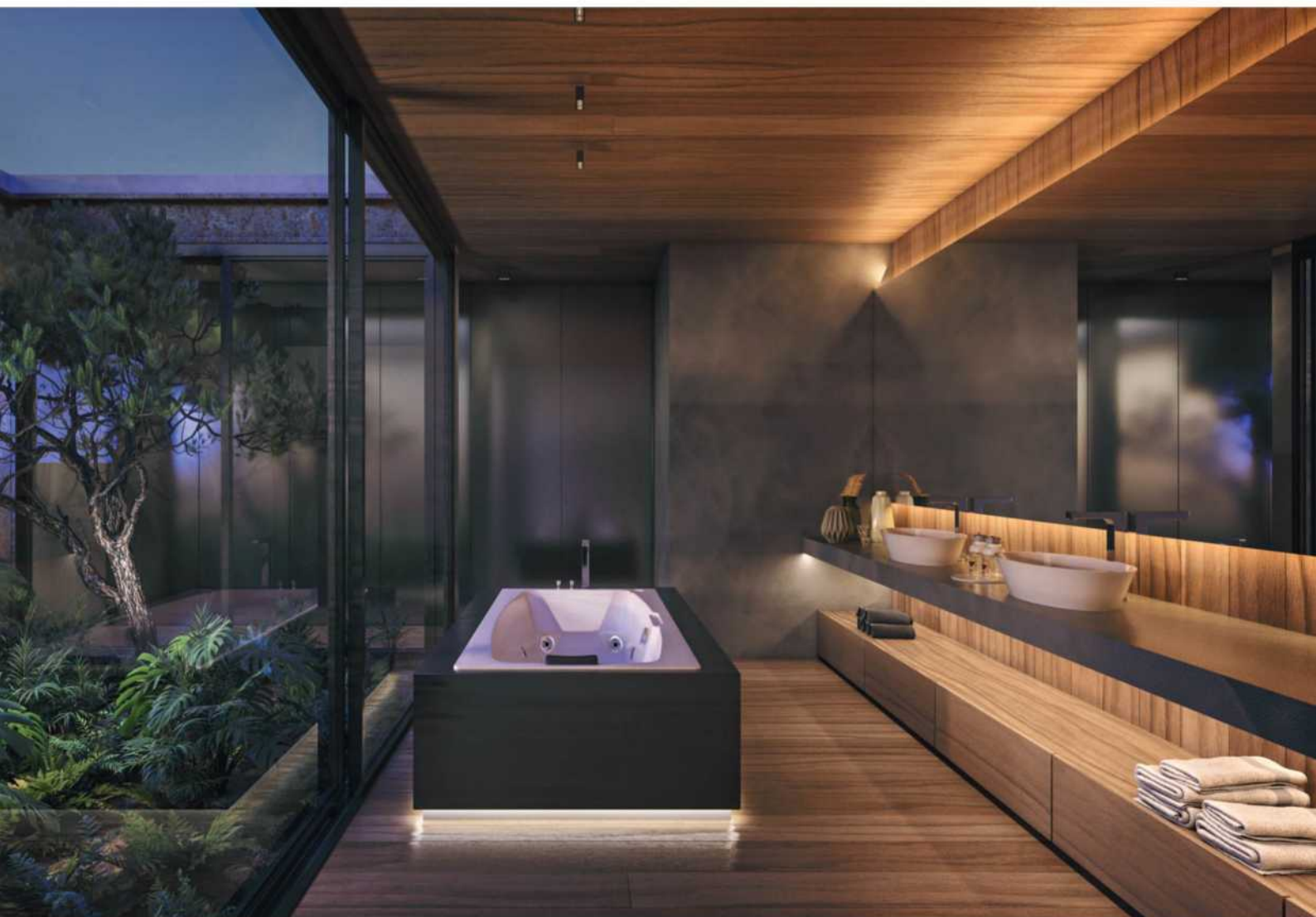

#### INFORMAÇÕES GERAIS

Luminária em alumínio injetado

 2700K / 3000K

CRI  
>90

 3-SDCM

 100-240V

 Dimerizável

 50 000 h

 540 lm / 1120 lm



## INFORMAÇÕES ADICIONAIS

POTÊNCIA		FLUXO LUMINOSO [lm]
5 W	3 focos	540
10 W	6 focos	1120

**UGR** <10    **CRI** >90    3-SDCM    100-240V    **IP**<sub>20</sub>

## CONTROLE

**TRIAC**  
Dimm

## CORES



## ANTIOFUSCANTE



## DISTRIBUIÇÃO DE LUZ



## APLICAÇÃO



## DESENHOS TÉCNICOS

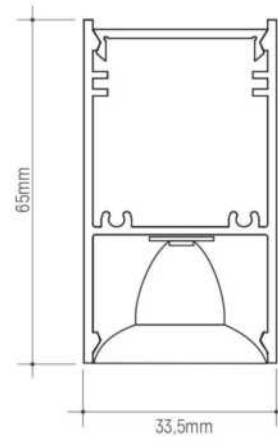

## CURVAS FOTOMÉTRICAS

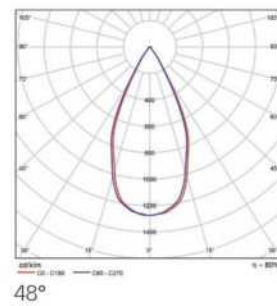
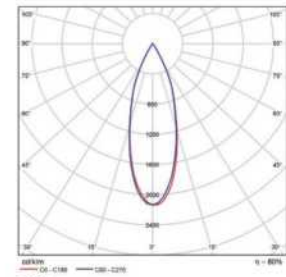
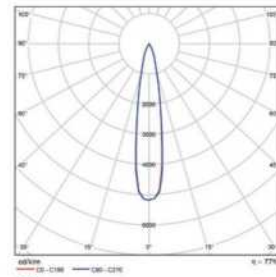





A dark, minimalist scene featuring a horizontal track with two spotlights. The word "SPOTS" is centered in a light, serif font. The background is a dark, textured surface, possibly a wall or ceiling, with a horizontal line running across the middle. The lighting is focused on the spotlights and the text, creating a dramatic, low-key effect.

S P O T S



# TUBE

Luminária versátil e delicada para uso de sobrepor em ambientes internos. Tube possui excelente controle de orientação e ofuscamento.

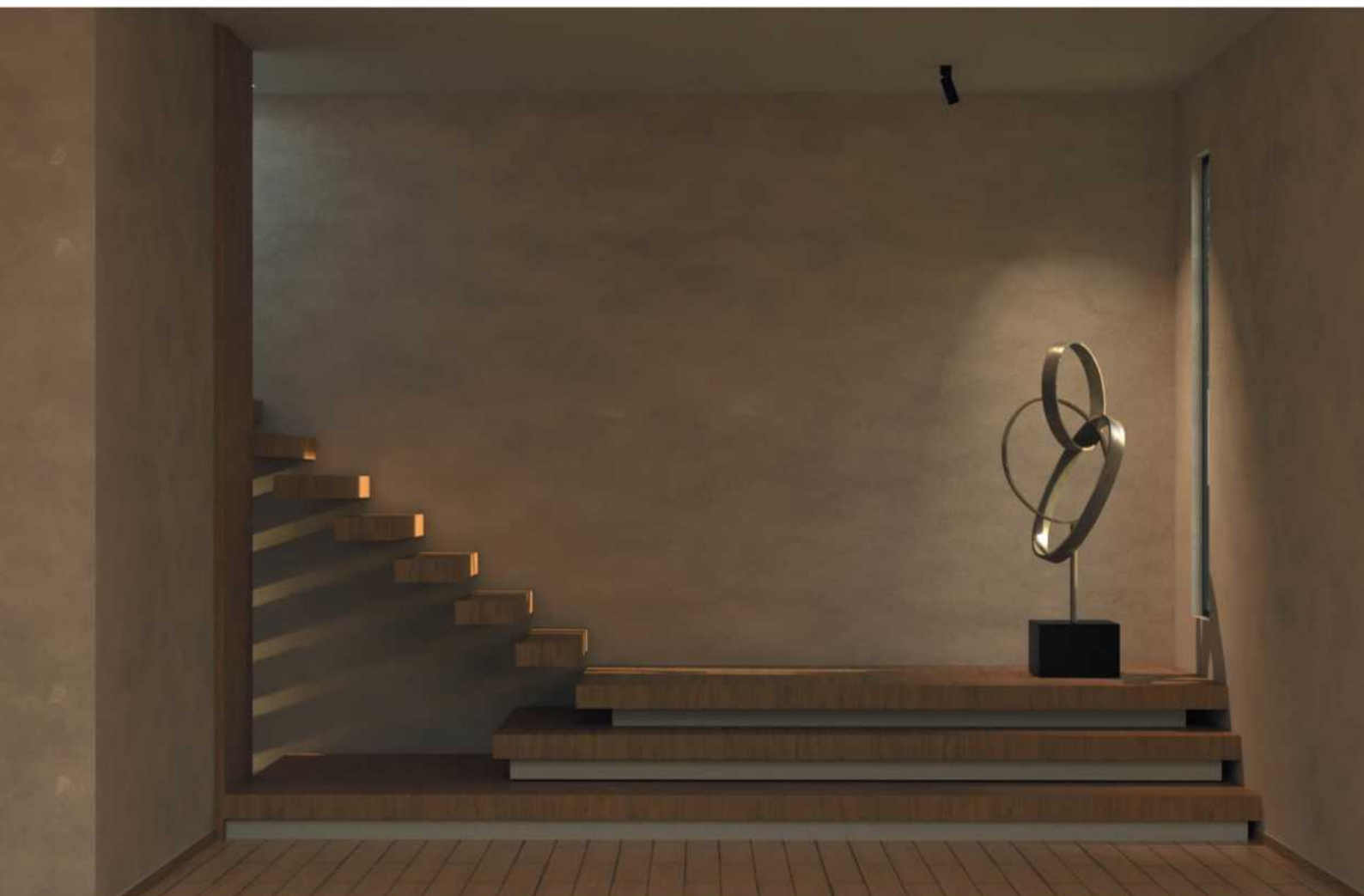

#### INFORMAÇÕES GERAIS

Luminária em alumínio injetado

 2700K / 3000K

CRI  >90  3-SDCM  220-240V

 50 000 h

 550 lm / 900 lm

INFORMAÇÕES ADICIONAIS

POTÊNCIA	FLUXO LUMINOSO [lm]
7W	550
12W	900

**UGR** <16    **CRI** >90    3-SDCM    220-240V    **IP**<sub>20</sub>

DESENHOS TÉCNICOS

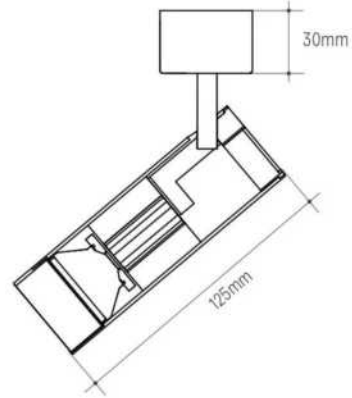

CONTROLE



CURVAS FOTOMÉTRICAS

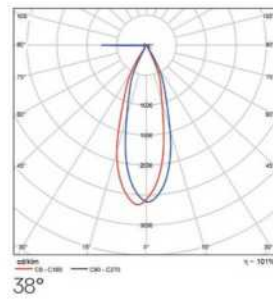

AJUSTES



CORES



DISTRIBUIÇÃO DE LUZ



APLICAÇÃO









# FINN

Spot orientável refinado e prático voltado para o uso em sistemas de perfis ou aplicações individuais. Finn possui excelente controle de ofuscamento e versatilidade com uso de acessórios Honeycomb e lente com efeito oval.



#### INFORMAÇÕES GERAIS

Luminária em alumínio injetado

 2700K / 3000K

CRI >90

 3-SDCM

 110-240V

 Dimerizável



 50 000 h

 650 lm

## INFORMAÇÕES ADICIONAIS

POTÊNCIA	FLUXO LUMINOSO [lm]
9W	550

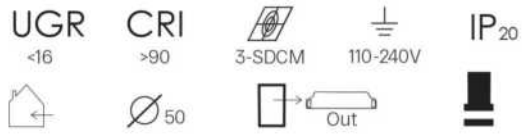

## CONTROLE



## AJUSTES



## CORES



## ANTIOFUSCANTE



## DISTRIBUIÇÃO DE LUZ



## APLICAÇÃO



## DESENHOS TÉCNICOS

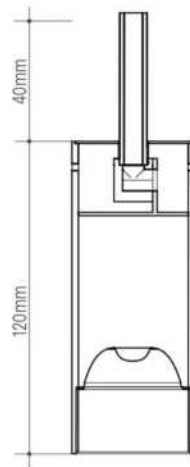

## CURVAS FOTOMÉTRICAS

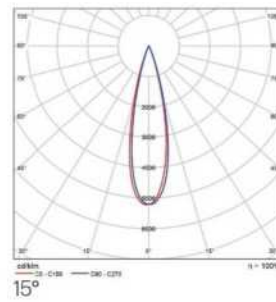

## ACESSÓRIOS



RHOMBIC  
Efeito Oval



HONEYCOMB  
Controle de Ofuscamento







P E R F I S



# MAKE

Perfil nas versões difusor alto e baixo com uso de fita de LED.





INFORMAÇÕES GERAIS

Difusor baixo

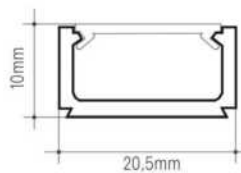

Difusor alto

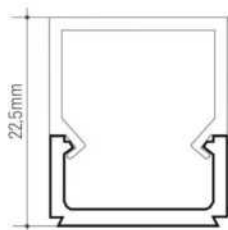
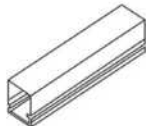

Perfil em alumínio extrudado



CORES



# MAKE

## DIFUSOR BLACK

Seguindo tendência, o make black apresenta uma solução inovadora com a tecnologia de difusor black.

Quando desligado, temos um perfil totalmente preto e quando ligado, mostra o caminho da luz de uma forma discreta.



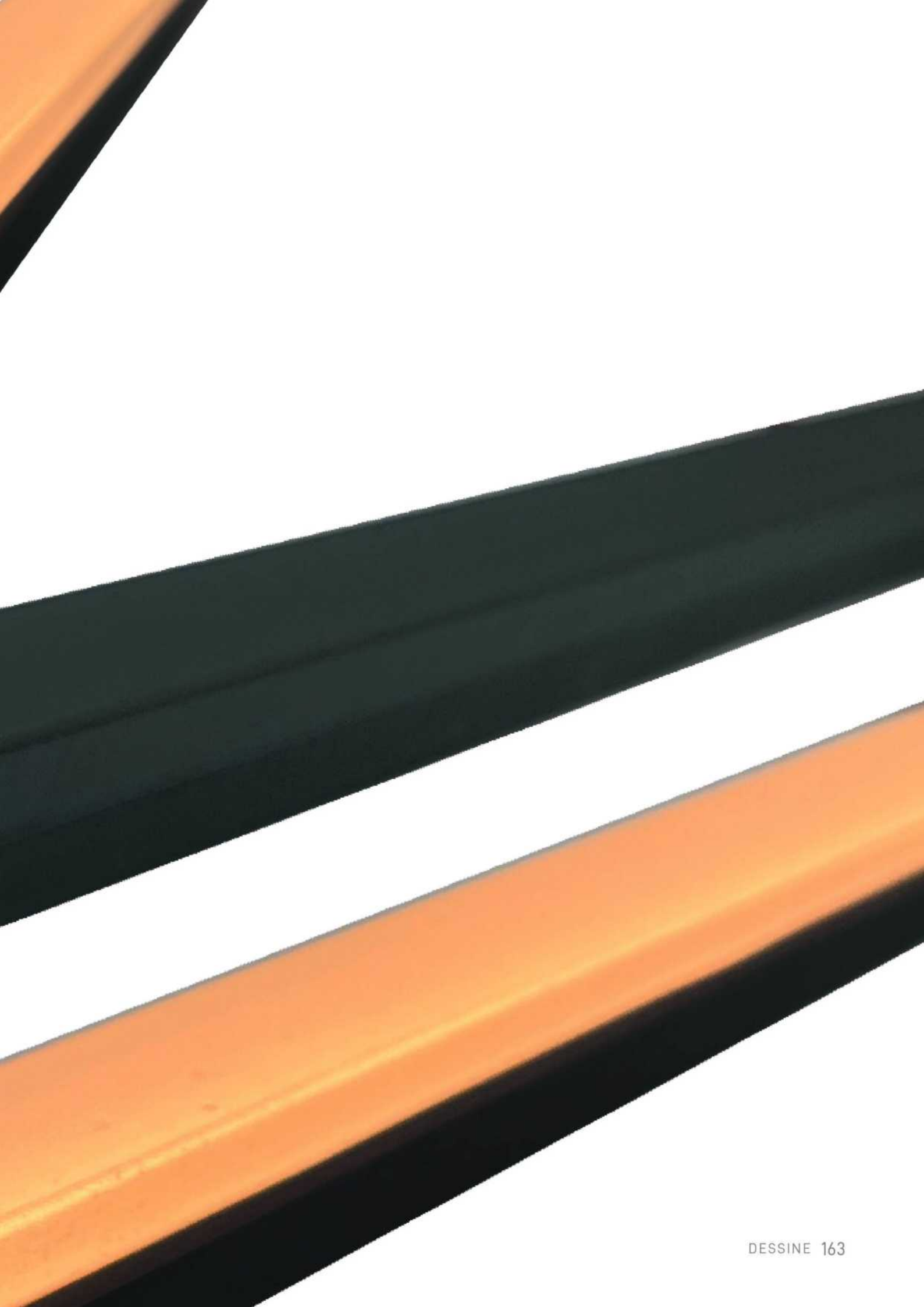

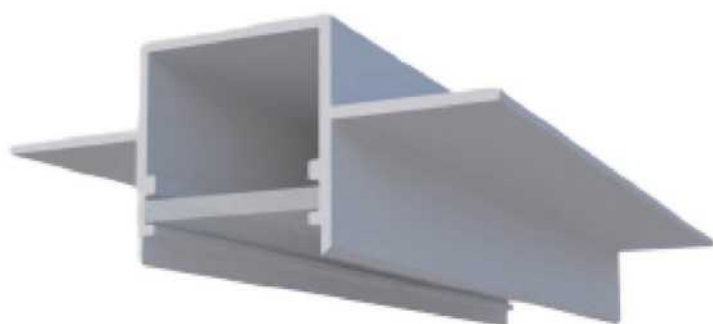

MINI

# INFINITY

Perfil no frame minimalista com difusor flexível sem emendas até 25m. Mini Infinity apresenta o conceito de luz neon.

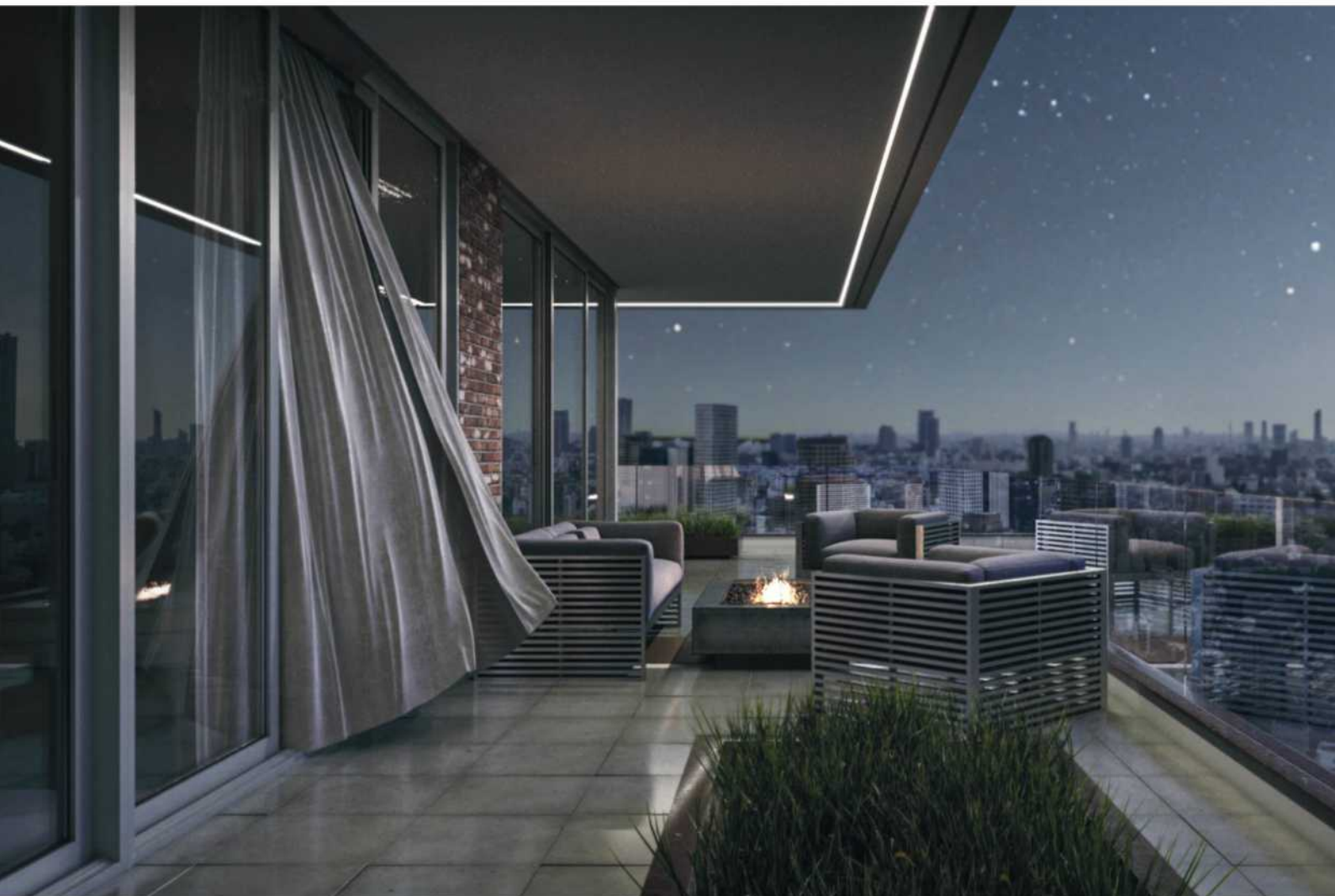

INFORMAÇÕES GERAIS

Perfil em alumínio extrudado



CORES

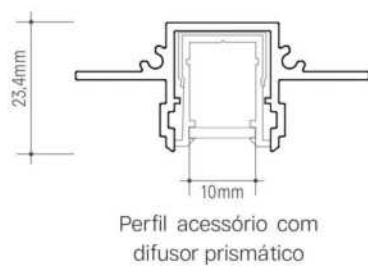
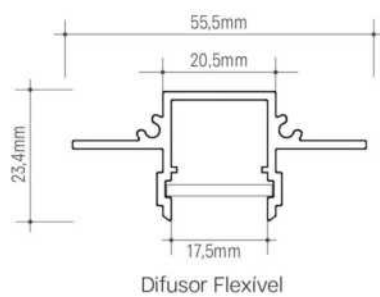



# RAGGIO

Perfil projetado para iluminar espaços utilizando a tecnologia LED integrado. Disponível nas versões embutir com borda e sobrepor.



#### INFORMAÇÕES GERAIS

Perfil em alumínio extrudado

 2700K / 3000K / 4000K

CRI  
>80

 3-SDCM

 110-240V

 Dimerizável

 50 000 h

 4910 lm/m



## INFORMAÇÕES ADICIONAIS

POTÊNCIA	APLICAÇÃO	DIMENSÃO	FLUXO LUMINOSO (lm)
35 W	Embutir	1,14m	4910
35 W	Sobrepor	1,14m	4910
52 W	Embutir	1,70m	7365
52 W	Sobrepor	1,70m	7365
70 W	Embutir	2,26m	9820
70 W	Sobrepor	2,26m	9820

**UGR** <20    **CRI** >80    3-SDCM    220-240V    **IP** 20

Out

## CONTROLE



## CORES



## DISTRIBUIÇÃO DE LUZ



## APLICAÇÃO



## DESENHOS TÉCNICOS

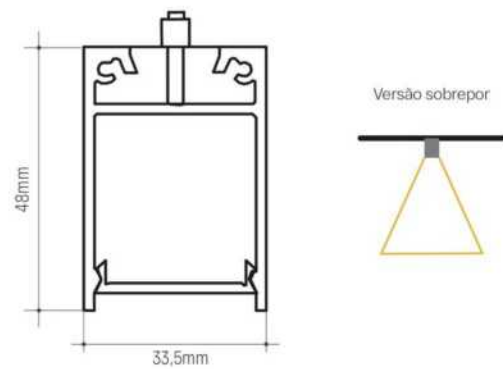
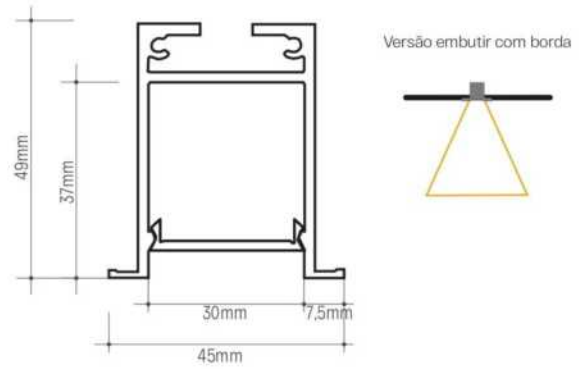

## CURVAS FOTOMÉTRICAS

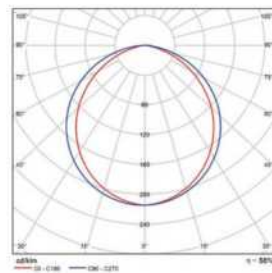







MINI

# RAGGIO

Perfil sob medida nas versões  
sobrepôr e embutir com borda.



## INFORMAÇÕES GERAIS

Perfil em alumínio extrudado

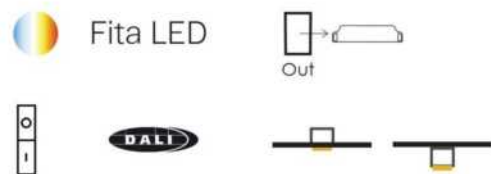

## CORES

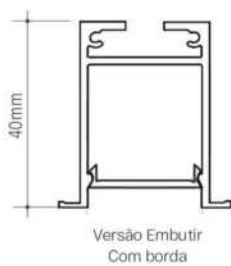
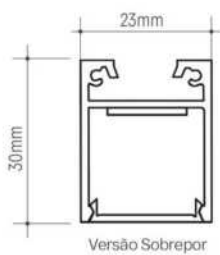



# TRACCIA

Pequeno perfil para aplicação em forros de madeira e marcenaria. Traccia possui um exclusivo difusor prismático deixando a luz mais natural e confortável.



INFORMAÇÕES GERAIS

Perfil em alumínio extrudado

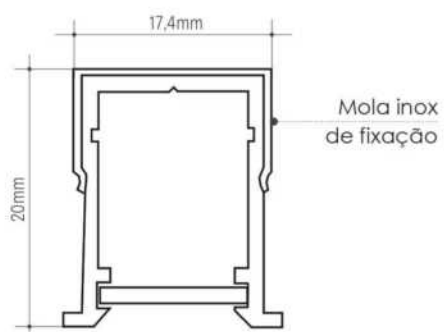

\*Requer nicho na marcenaria



CORES





# TRECK

Perfil para aplicação em forros de gesso e difusor flexível recuado que oferece maior conforto visual. Disponível nas versões noframe e com borda

INFORMAÇÕES GERAIS

Perfil em alumínio extrudado



CORES



DESENHO TÉCNICO

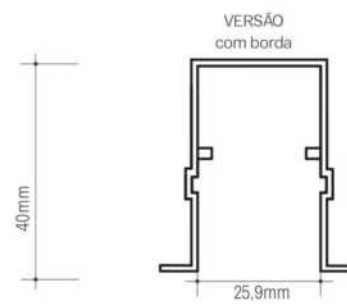
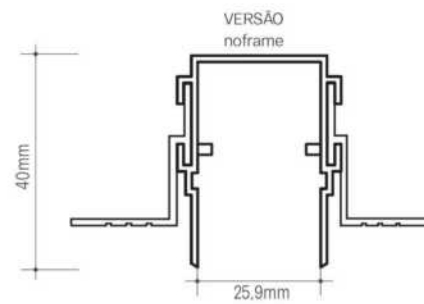



# LIMIT

Perfil idealizado para iluminar caminhos de forma discreta e sua principal aplicação é como rodapé iluminado.



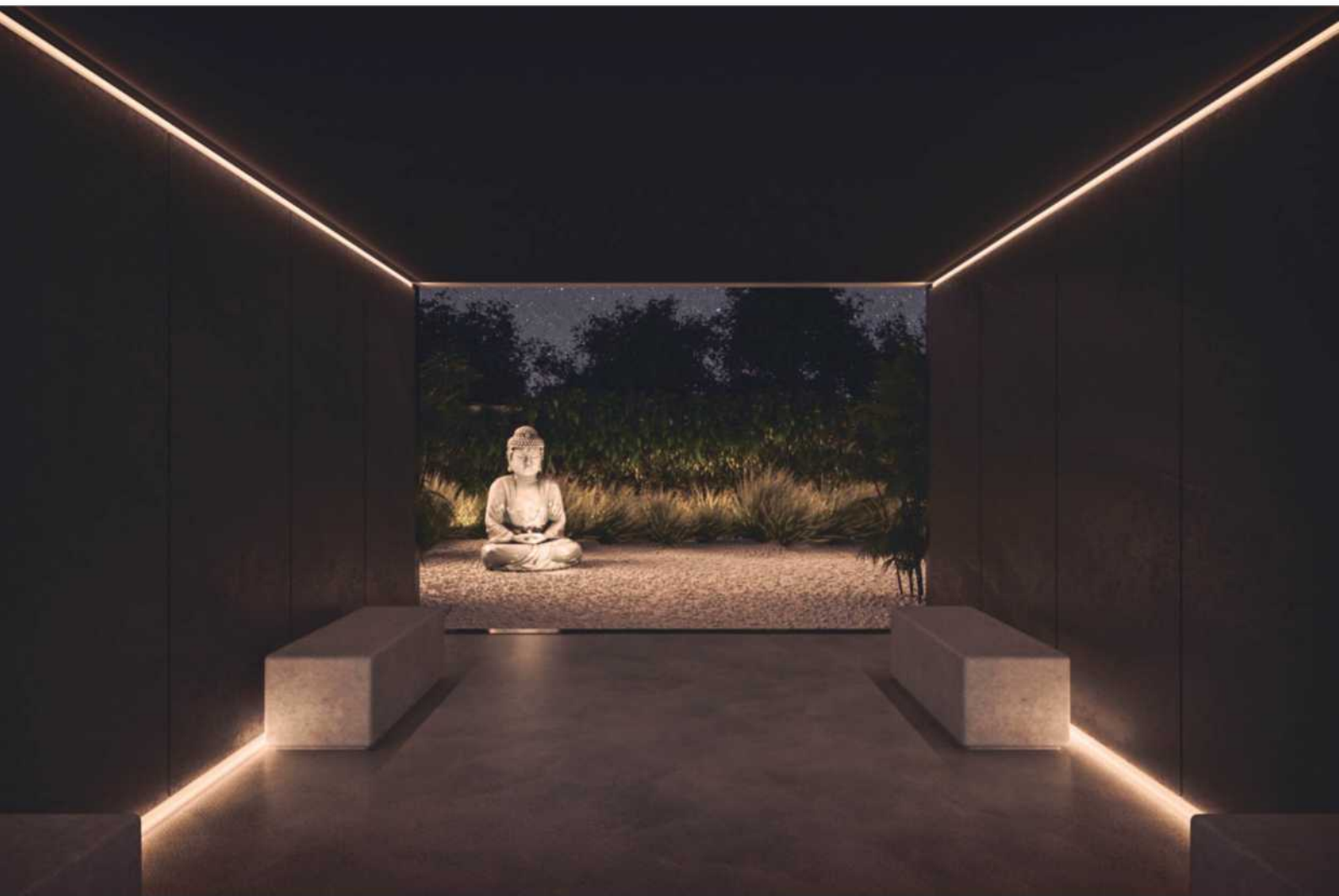

INFORMAÇÕES GERAIS

Perfil em alumínio extrudado

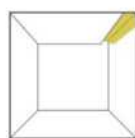
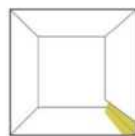
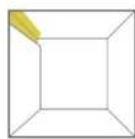
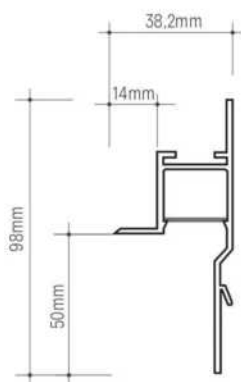

 Fita LED

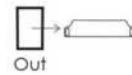

CORES





# ASSY

Micro perfil assimétrico para  
marcenaria com design  
tecnológico que torna a fonte de  
luz imperceptível.



## INFORMAÇÕES GERAIS

Perfil em alumínio extrudado

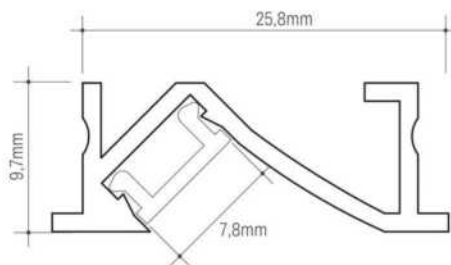

\*Requer nicho na marcenaria



## CORES





# PLY

Perfil minimalista e inovador para aplicação em paredes e tetos. Torna-se imperceptível após acabamento de pintura.

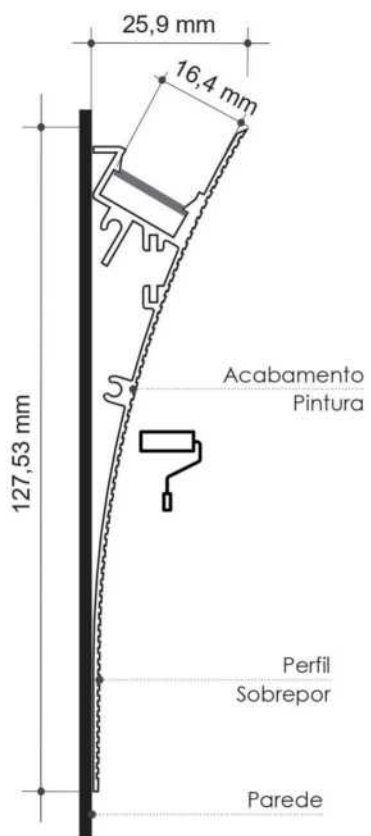
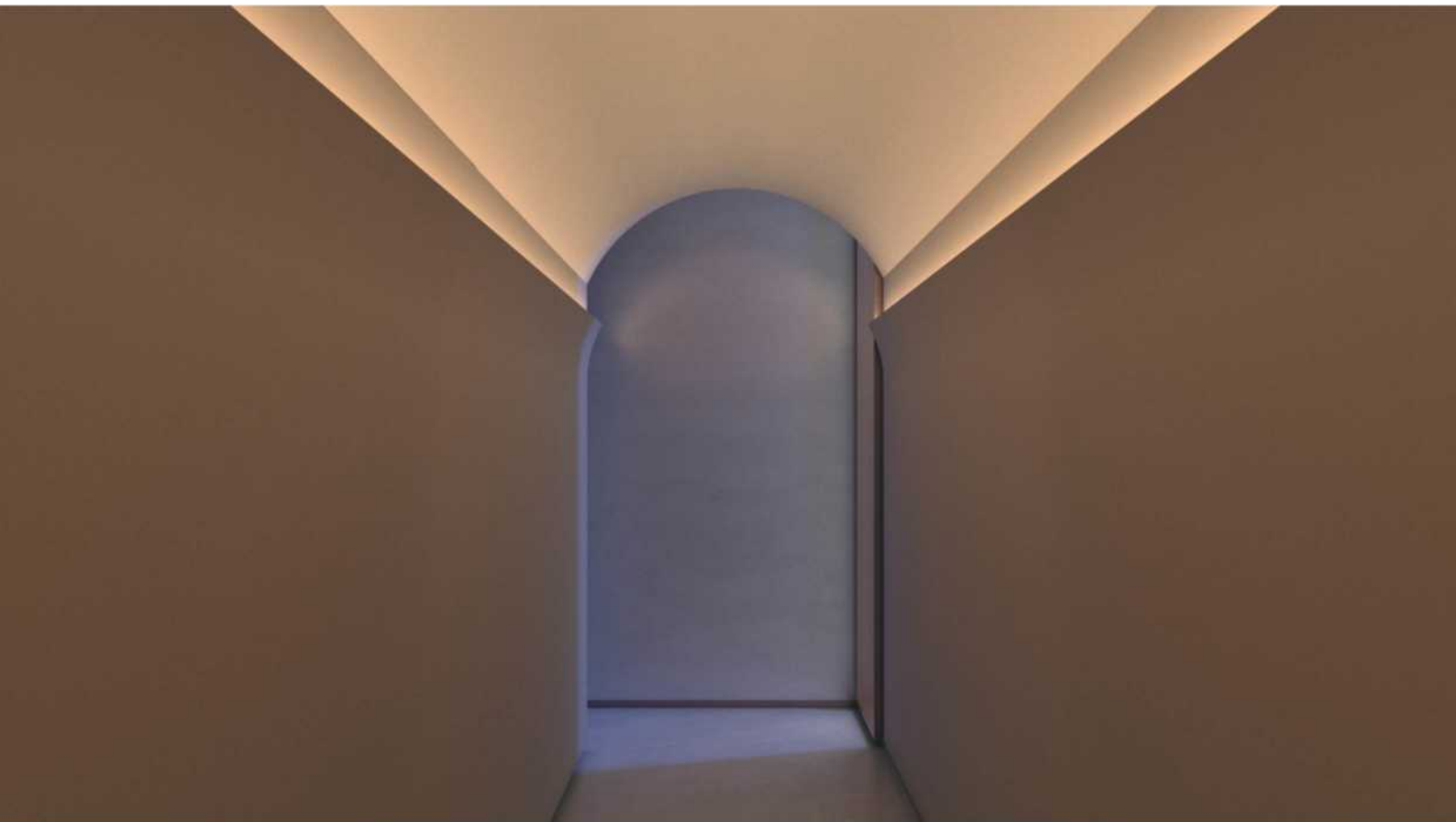

#### INFORMAÇÕES GERAIS

Perfil em alumínio extrudado

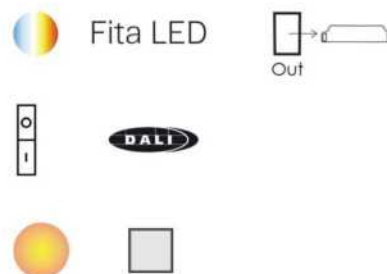



# ZERO G

Perfil de luz indireta com a tecnologia elastic steel e com tensionamento perfeito até 20 metros.



## INFORMAÇÕES GERAIS

Perfil em alumínio extrudado / injetado



 Fita LED

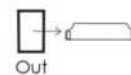





INFORMAÇÕES ADICIONAIS

CRI  
≥90

3-SDCM

220-240V

IP<sub>20</sub>



CONTROLE



CORES



DISTRIBUIÇÃO DE LUZ



APLICAÇÃO

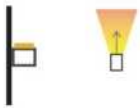

DESENHOS TÉCNICOS

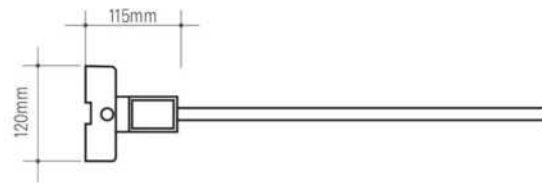

\*Alimentação unilateral

FIXAÇÃO

\*Vista Superior

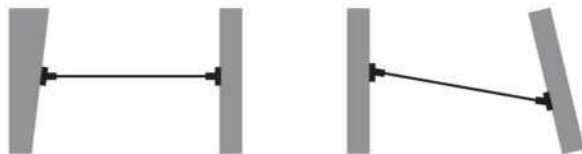

ILUMINAÇÃO

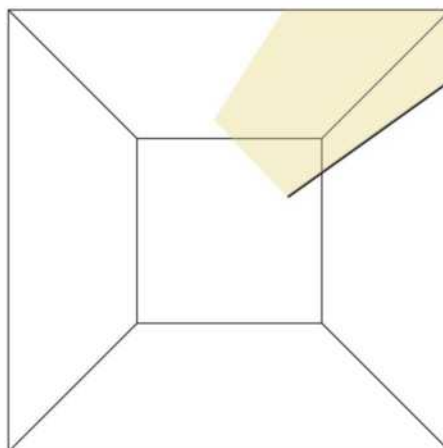









ARANDELAS



# BENT

Arandela de luz indireta com LED integrado e design sofisticado.



#### INFORMAÇÕES GERAIS

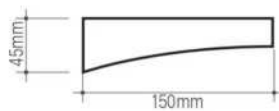

Luminária em alumínio extrudado

 2700K / 3000K

CRI  
>90

 3-SDCM

 100-240V

 Dimerizável

 50 000 h

 4910 lm / 9180 lm

## INFORMAÇÕES ADICIONAIS

POTÊNCIA		FLUXO LUMINOSO [lm]
35W	60cm	4910
70W	120cm	9820



## CONTROLE



## CORES



## DISTRIBUIÇÃO DE LUZ



## APLICAÇÃO



## DESENHOS TÉCNICOS

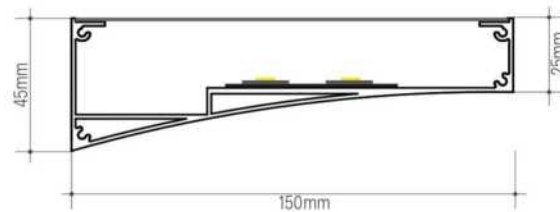
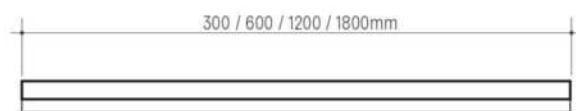





# MASSIMO

...a de LED integrado  
...nizável nas versões  
...or e pendente. Conta com  
...os luminotécnicos de luz



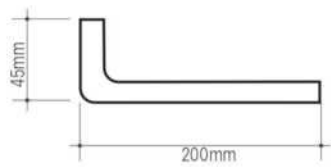
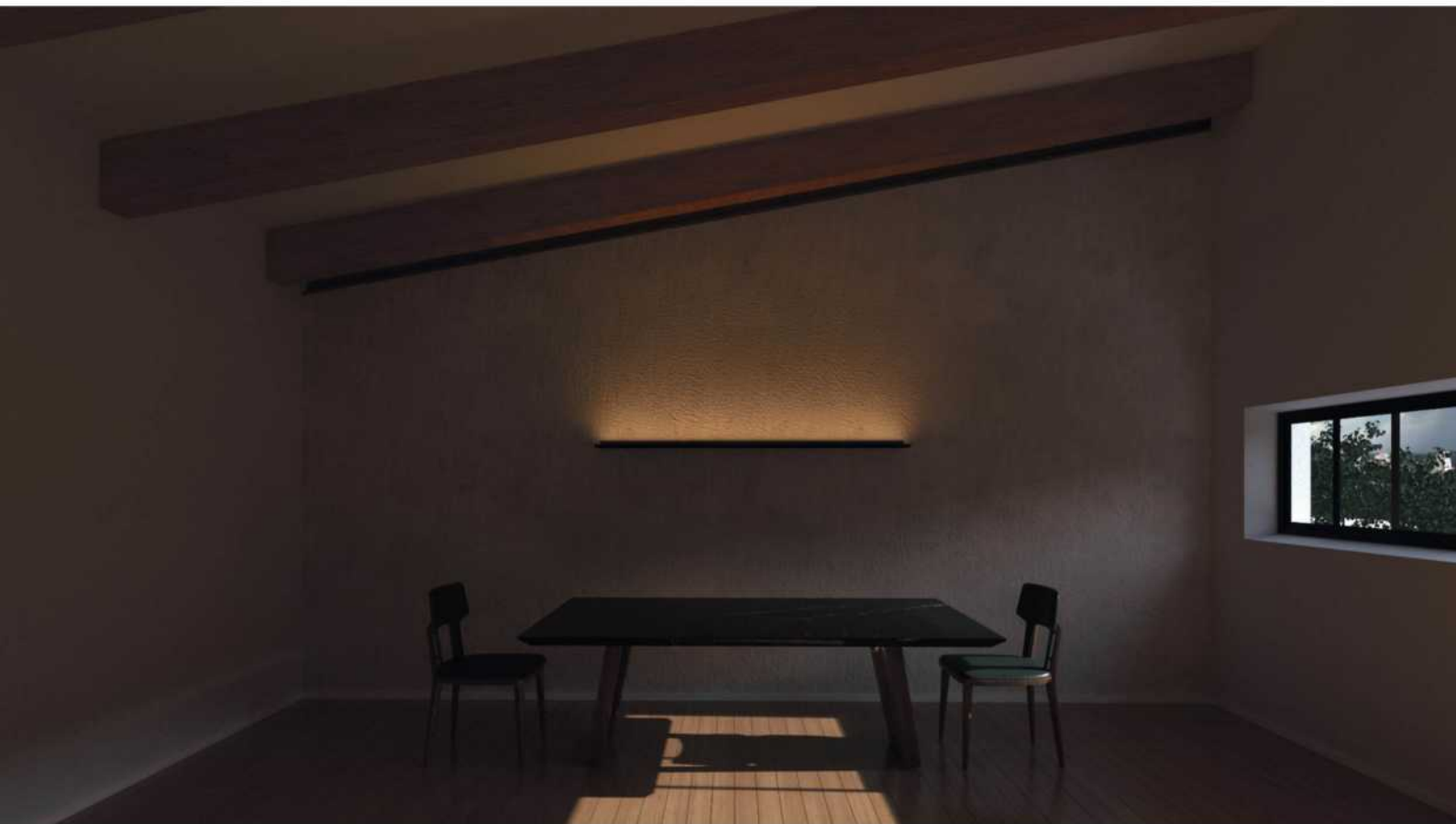

## INFORMAÇÕES GERAIS

Perfil em alumínio extrudado



## CORES





# BOSS

Arandela com luz indireta e efeito áurea para ambientes externos e que precisam de proteção à umidade.

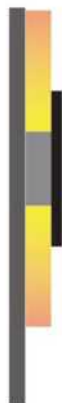
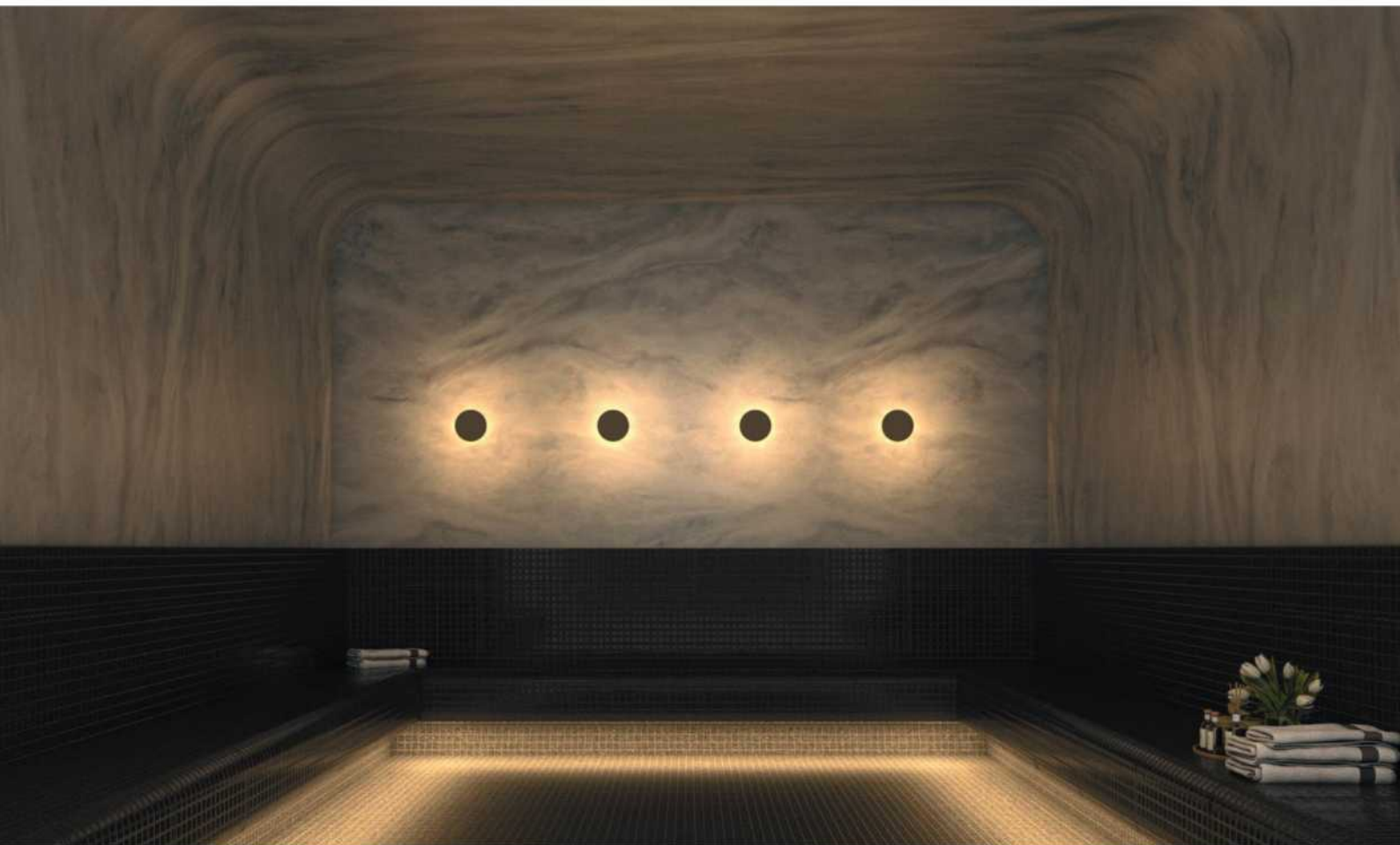

#### INFORMAÇÕES GERAIS

Luminária em alumínio injetado

 3000K

CRI  
>90

 3-SDCM

 100-277V

 50 000 h

 1800 lm

## INFORMAÇÕES ADICIONAIS

POTÊNCIA	FLUXO LUMINOSO [lm]
12,6W	1800

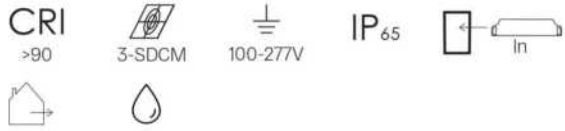

## CONTROLE



## CORES



## DISTRIBUIÇÃO DE LUZ



## APLICAÇÃO



## DESENHOS TÉCNICOS

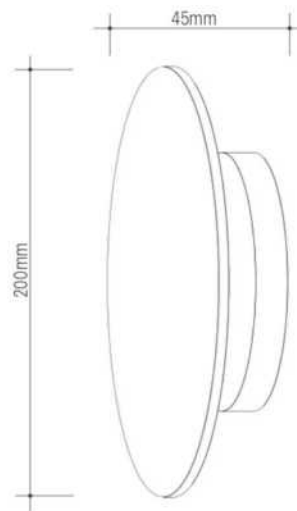

## CURVAS FOTOMÉTRICAS

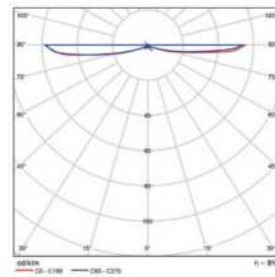







S I S T E M A S



# THIN

Arandela delicada para uso de luz indireta e com conceito minimalista.



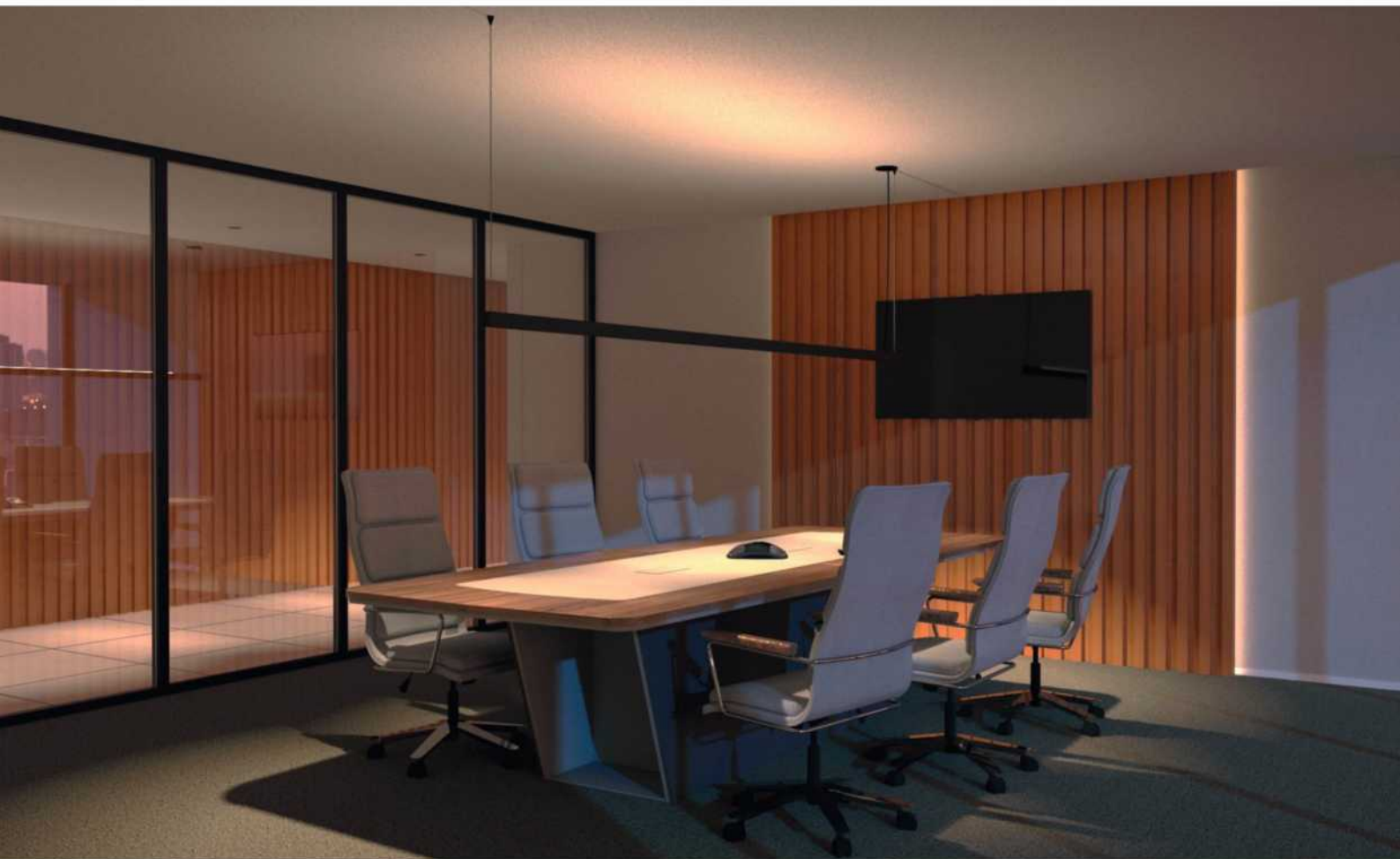

INFORMAÇÕES GERAIS

Perfil em alumínio extrudado

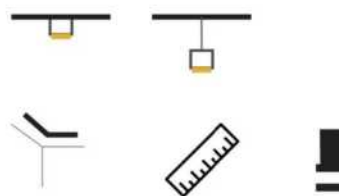

CORES

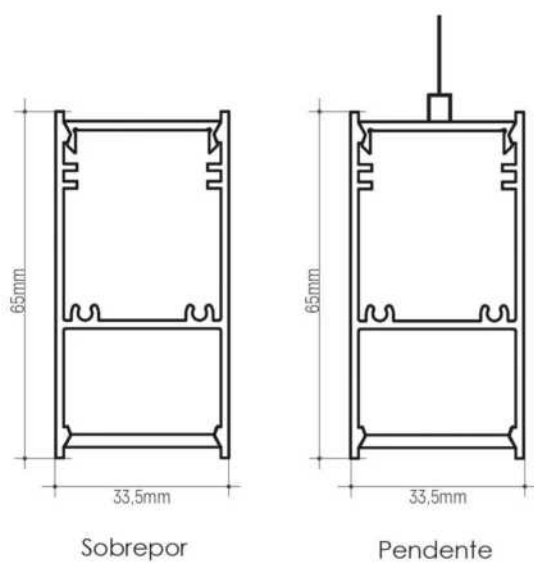

## FINN



Spot orientável refinado e prático. Finn possui excelente controle de ofuscamento e versatilidade com uso de diversos acessórios.

### INFORMAÇÕES GERAIS

Luminária em alumínio injetado

 2700K / 3000K

CRI  
>90

 3-SDCM

 110-240V

 Dimerizável



 50 000 h

 650 lm

## FINN zoom



Spot com ajuste preciso do ângulo da luz, variando de 10° a 60° e com excelente controle de ofuscamento.

### INFORMAÇÕES GERAIS

Luminária em alumínio injetado

 2700K / 3000K

CRI  
>90

 3-SDCM

 100-240V

 Dimerizável

 50 000 h

 550 lm

## OSLO



Componente multifocos dark light com o melhor desempenho do mercado e o menor grau de ofuscamento.

### INFORMAÇÕES GERAIS

Luminária em alumínio injetado

 2700K / 3000K

CRI  
>80/90

 3-SDCM

 100-240V

 Dimerizável

 50 000 h

 540 lm / 1120 lm

## LUZ DIFUSA



Componente com tecnologia de LED integrado de alto fluxo luminoso.

### INFORMAÇÕES GERAIS

Luminária em alumínio injetado

 2700K / 3000K / 4000K

CRI  
>90

 3-SDCM

 100-240V

 Dimerizável

 50 000 h

 4910 / 9820 lm

INFORMAÇÕES ADICIONAIS

POTÊNCIA	FLUXO LUMINOSO [lm]
9 W	650

**UGR** <16    **CRI** >90    3-SDCM    110-240V    **IP**<sub>20</sub>

CONTROLE

**TRIAC Dimm**

AJUSTES

360°    0 - 90°

CORES



ANTIOFUSCANTE



DISTRIBUIÇÃO DE LUZ



APLICAÇÃO



DESENHOS TÉCNICOS FINN

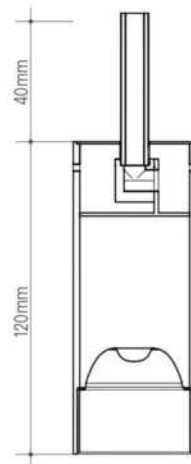

CURVAS FOTOMÉTRICAS

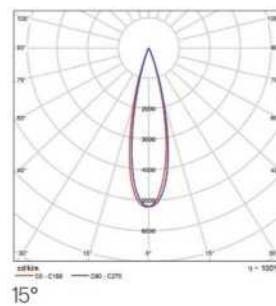

ACESSÓRIOS



RHOMBIC  
Efeito Oval



HONEYCOMB  
Controle de Ofuscamento

## INFORMAÇÕES ADICIONAIS

POTÊNCIA	FLUXO LUMINOSO [lm]
9 W	550

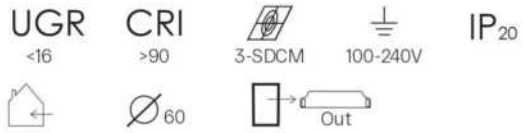

## CONTROLE



## AJUSTES



## CORES



## ANTIOFUSCANTE



## DISTRIBUIÇÃO DE LUZ



## APLICAÇÃO



## DESENHOS TÉCNICOS FINN ZOOM

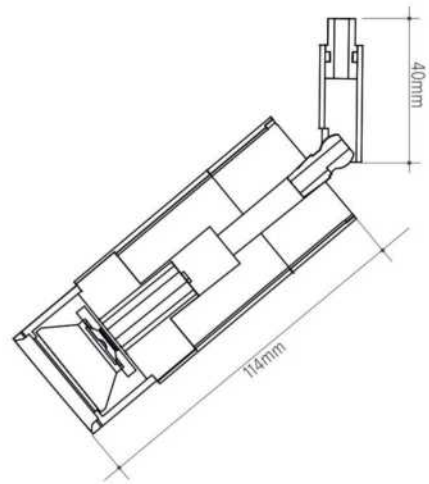

INFORMAÇÕES ADICIONAIS

POTÊNCIA		FLUXO LUMINOSO [lm]
5 W	3 focos	540
10 W	6 focos	1120

**UGR** <10    **CRI** >80/90    3-SDCM    100-240V    **IP<sub>20</sub>**

DESENHOS TÉCNICOS OSLO

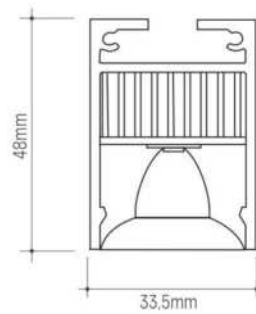

CONTROLE

TRIAC Dimm    DALI

CURVAS FOTOMÉTRICAS

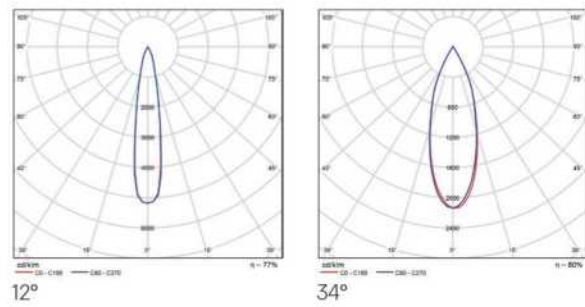

CORES

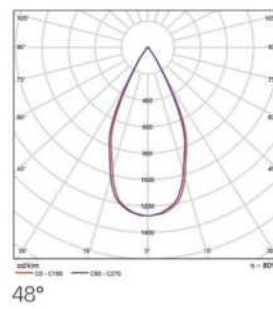

ANTIOFUSCANTE



DISTRIBUIÇÃO DE LUZ



APLICAÇÃO







# INFINITY

Sistema de LED integrado customizável para aplicação de embutir em gesso. Conta com recursos luminotécnicos de luz difusa, multifocos e spots.





#### INFORMAÇÕES GERAIS

Perfil em alumínio extrudado

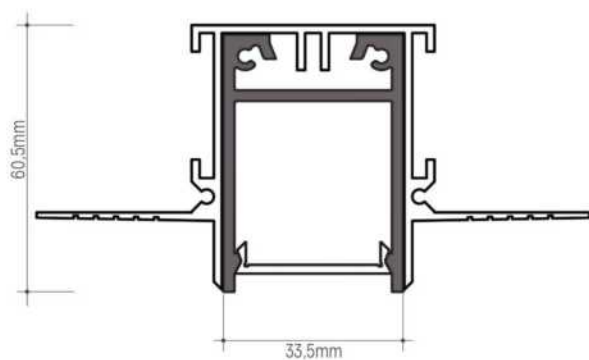

CORES



## FINN



Spot orientável refinado e prático. Finn possui excelente controle de ofuscamento e versatilidade com uso de diversos acessórios.

### INFORMAÇÕES GERAIS

Luminária em alumínio injetado

 2700K / 3000K

CRI  
>90

 3-SDCM

 110-240V

 Dimerizável



 50 000 h

 650 lm

## FINN zoom



Spot com ajuste preciso do ângulo da luz, variando de 10° a 60° e com excelente controle de ofuscamento.

### INFORMAÇÕES GERAIS

Luminária em alumínio injetado

 2700K / 3000K

CRI  
>90

 3-SDCM

 100-240V

 Dimerizável

 50 000 h

 550 lm

## OSLO



Componente multifocos com exclusivo sistema de máscara glossy e refletor, proporciona os mais baixos índices de ofuscamento.

### INFORMAÇÕES GERAIS

Luminária em alumínio injetado

 2700K / 3000K

CRI  
>80/90

 3-SDCM

 100-240V

 Dimerizável

 50 000 h

 540 lm / 1120 lm

## LUZ DIFUSA



Componente com tecnologia de LED integrado de alto fluxo luminoso.

### INFORMAÇÕES GERAIS

Luminária em alumínio injetado

 2700K / 3000K / 4000K

CRI  
>90

 3-SDCM

 100-240V

 Dimerizável

 50 000 h

 4910 lm / 9820 lm

## INFORMAÇÕES ADICIONAIS

POTÊNCIA	FLUXO LUMINOSO (lm)
9 W	650

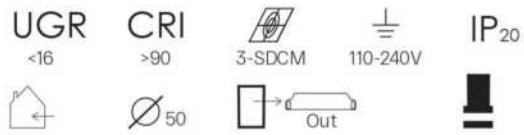

## CONTROLE



## AJUSTES



## CORES



## ANTI OFUSCANTE



## DISTRIBUIÇÃO DE LUZ



## APLICAÇÃO



## DESENHOS TÉCNICOS FINN

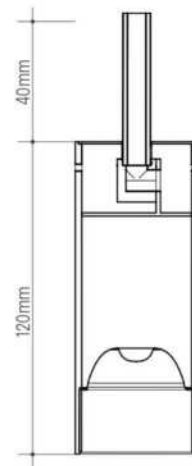

## CURVAS FOTOMÉTRICAS

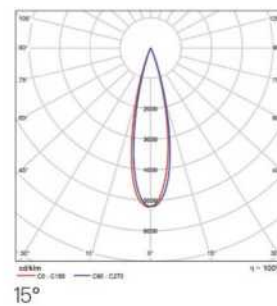

## ACESSÓRIOS



INFORMAÇÕES ADICIONAIS

DESENHOS TÉCNICOS FINN ZOOM

POTÊNCIA	FLUXO LUMINOSO (lm)
9W	550

**UGR** <16    **CRI** >90    3-SDCM    100-240V    IP<sub>20</sub>

CONTROLE

**TRIAC**  
Dimm    **DALI**

AJUSTES

360°    0 - 70°

CORES



ANTIOFUSCANTE



DISTRIBUIÇÃO DE LUZ

15° - 60°

APLICAÇÃO

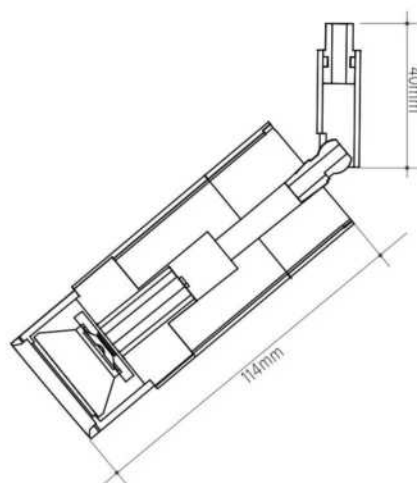

## INFORMAÇÕES ADICIONAIS

POTÊNCIA		FLUXO LUMINOSO (lm)
5 W	3 focos	540
10 W	6 focos	1120

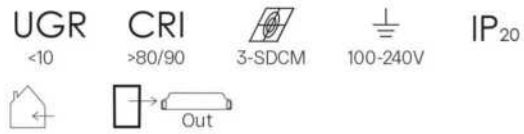

## CONTROLE



## CORES



## ANTIOFUSCANTE



## DISTRIBUIÇÃO DE LUZ



## APLICAÇÃO



## DESENHOS TÉCNICOS OSLO

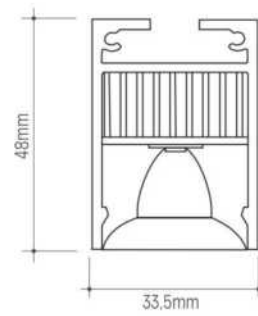

## CURVAS FOTOMÉTRICAS

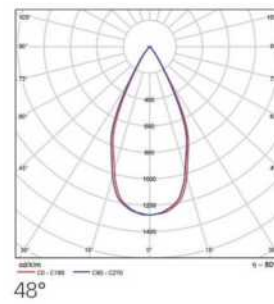
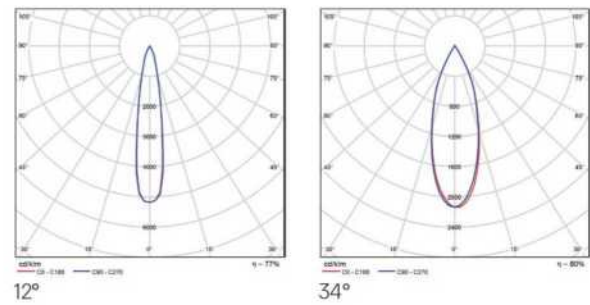



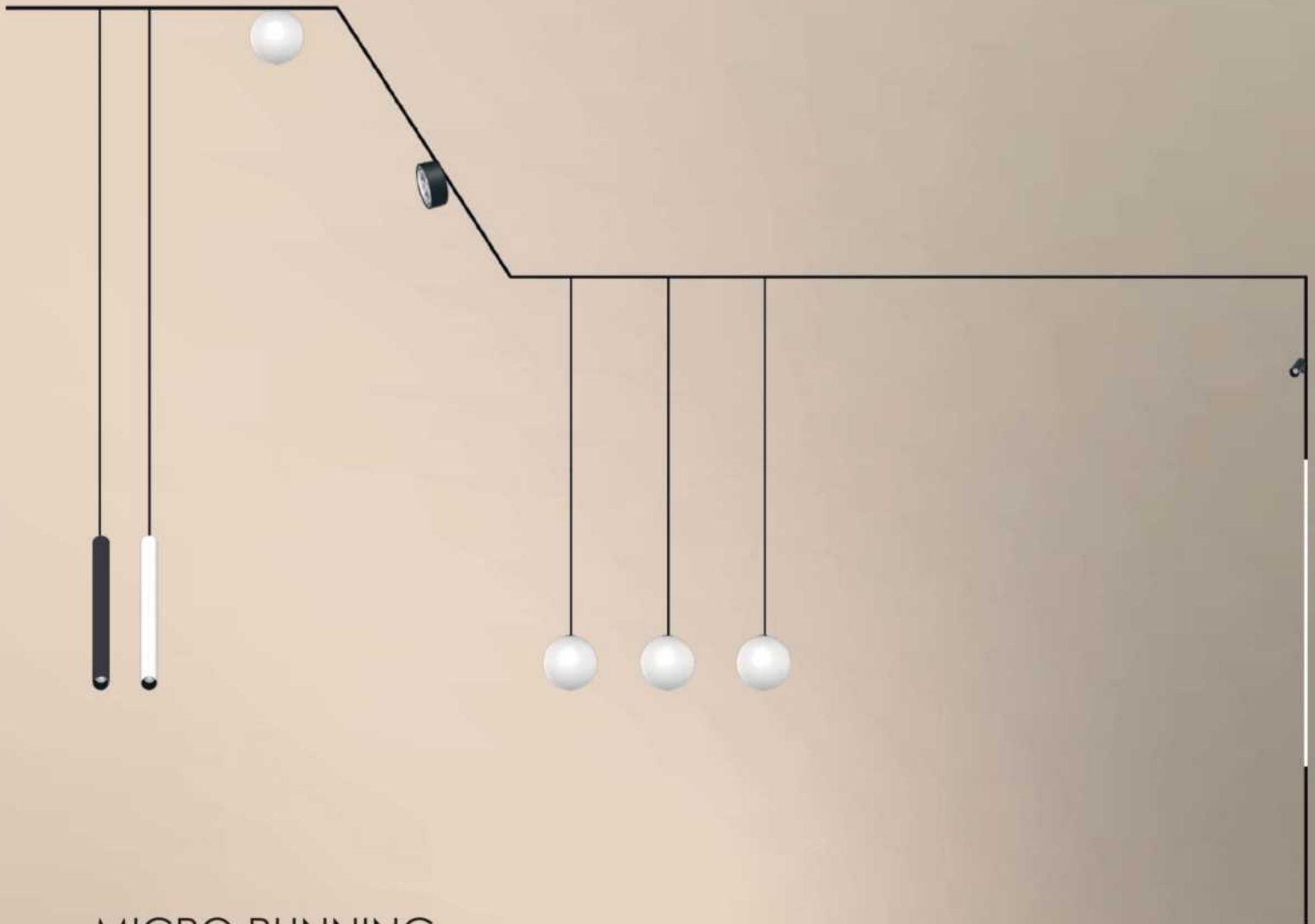

MICRO RUNNING

# MAGNET

Minimalista na sua essência e com alta tecnologia. Versátil e prático no melhor conceito de sistemas magnéticos. Na versão de embutir com apenas 7mm no acabamento final. E na versão sobrepor, um perfil com dimensões reduzidas.



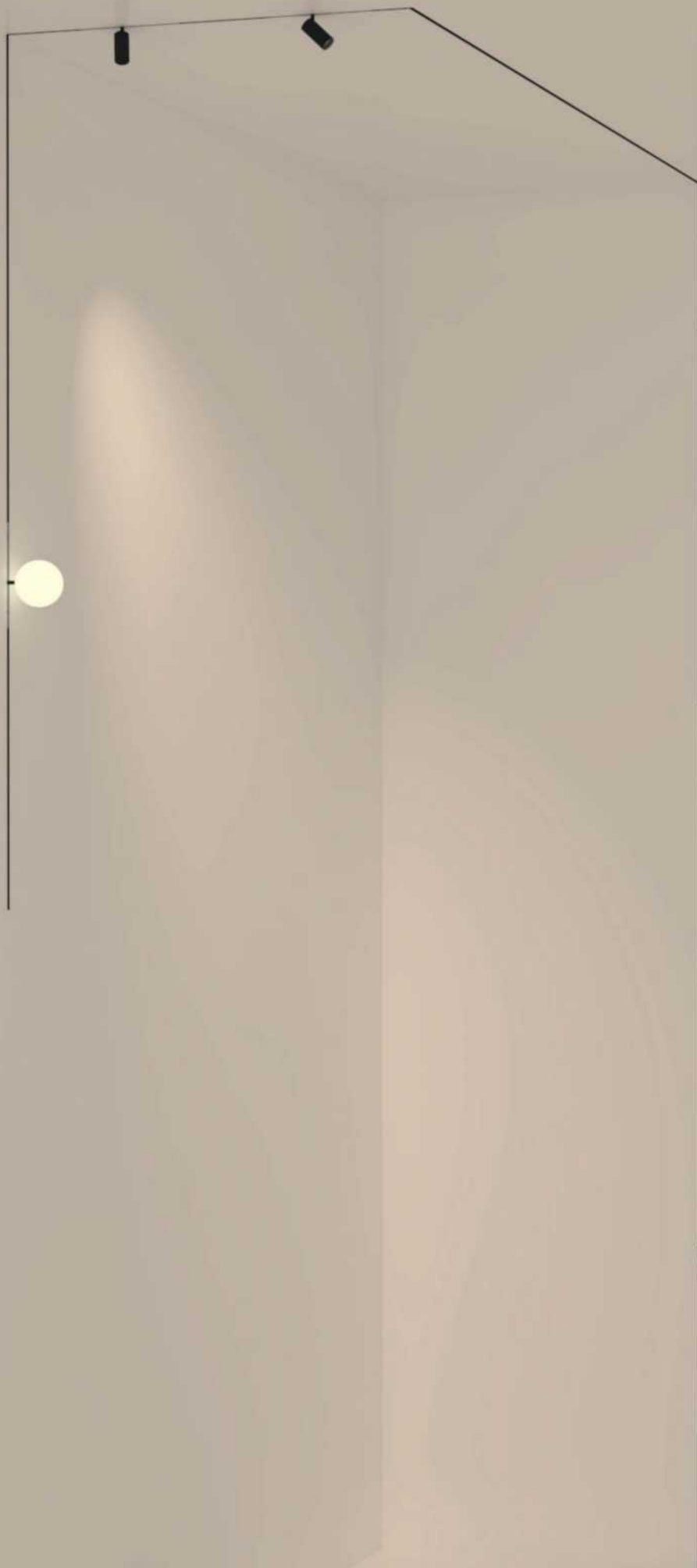

Perfil Micro Magnético

7mm

Minimalista

Versátil

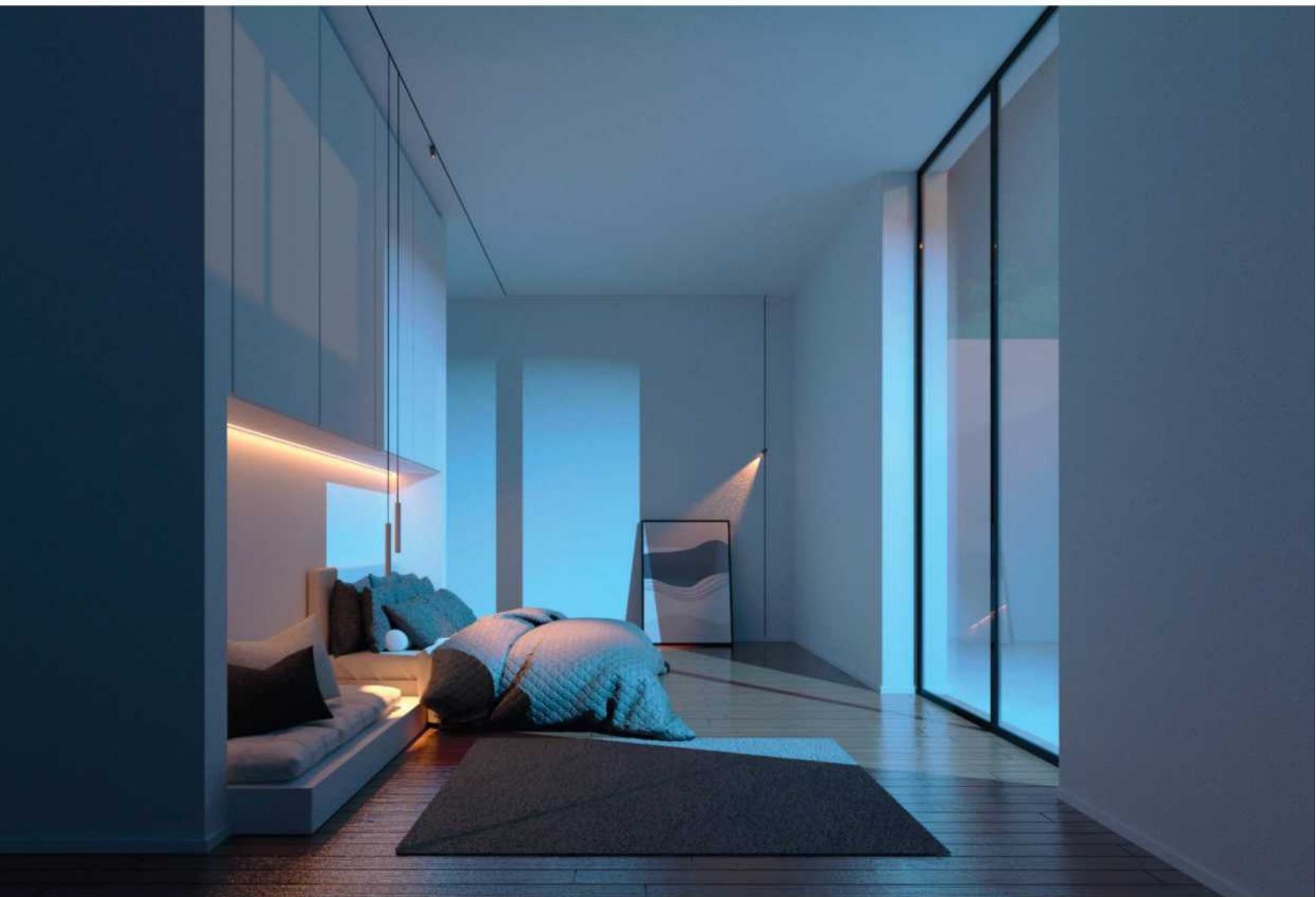

INFORMAÇÕES GERAIS

Perfil em alumínio extrudado

 2700K / 3000K

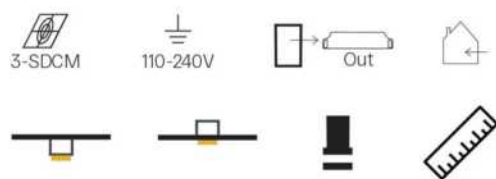

Item A



Item B



Item C



Item D



Item E



## COMPONENTES

Item A

\*Perfil 1m

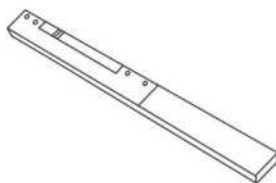

Item B

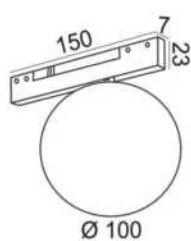

Item C

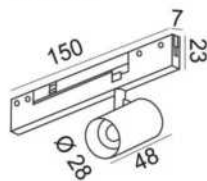

Item D

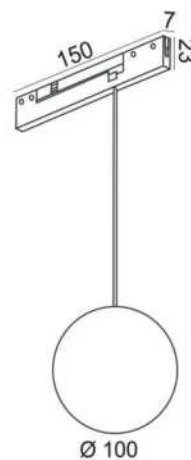

Item E

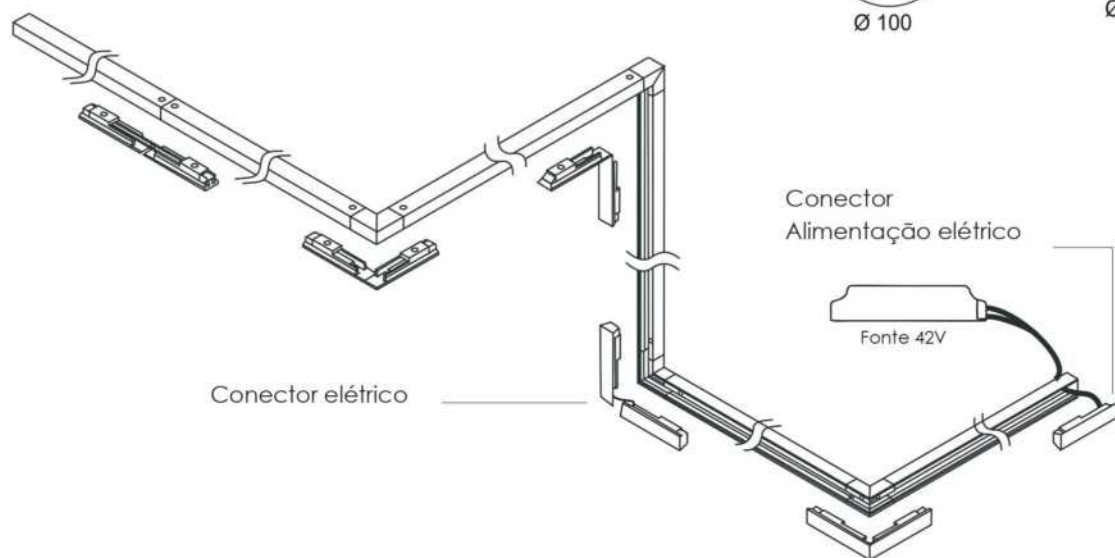
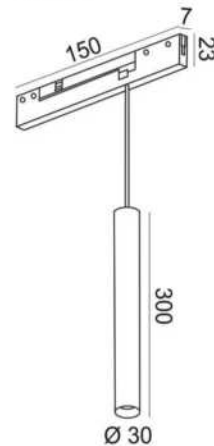

## DESENHO TÉCNICO

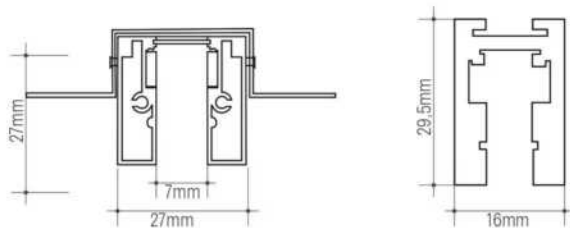

## CONTROLE



ITEM	TIPO	TEMPERATURA	FLUXO	POTENCIA	DISTRIBUIÇÃO
Item A	Perfil 1m	2700K / 3000K	290 lm	12 W	Difusa
	Perfil 2m	2700K / 3000K	580 lm	24W	Difusa
Item B	Arandela	3000K	250 lm	4,5 W	Difusa
Item C	Spot	2700K	395 lm	4,5 W	8° e 24°
Item D	Pendente	3000K	250 lm	4,5 W	Difusa
Item E	Pendente	2700K	670 lm	7 W	24°



# LINNES

Um sistema técnico decorativo inovador e versátil que possibilita diversas aplicações. Design minimalista com efeitos de luz difusa.



## INFORMAÇÕES GERAIS

Perfil em alumínio extrudado

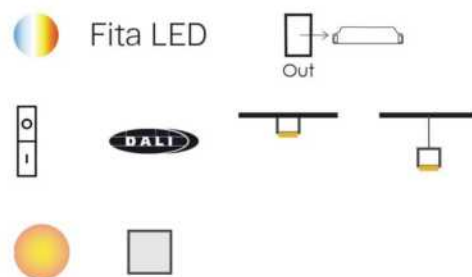
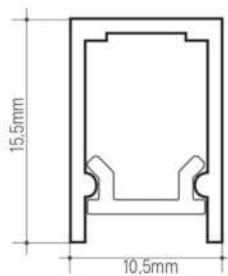

## CORES



## ARTICULAÇÃO

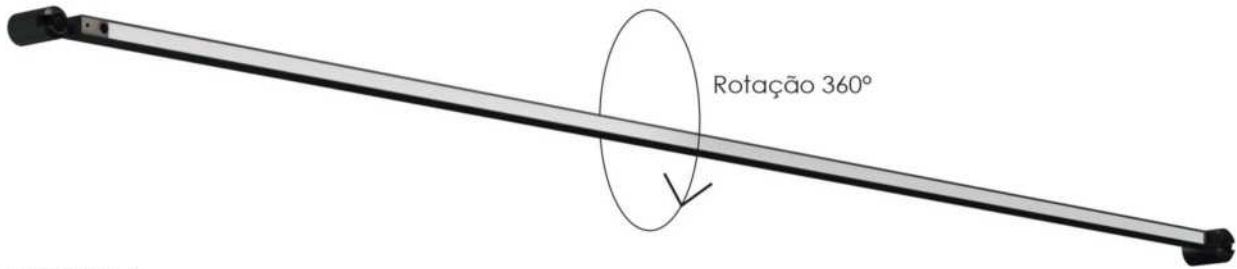

## SISTEMA

O sistema Linnes permite um completo ajusta de cada perfil, possibilitando a orientação e rotação completa de cada elemento e podendo ser projetado em diversas configurações.

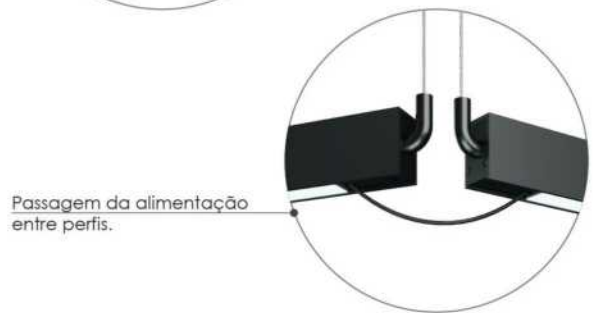
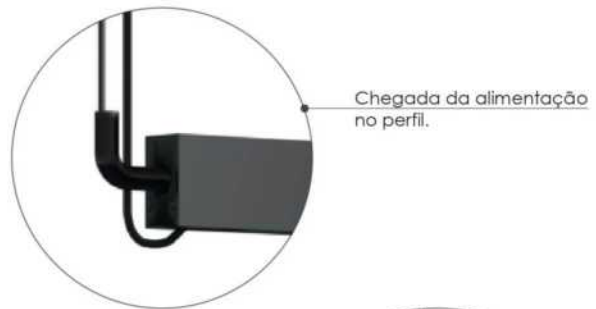

Articulação em piso



Articulação em parede

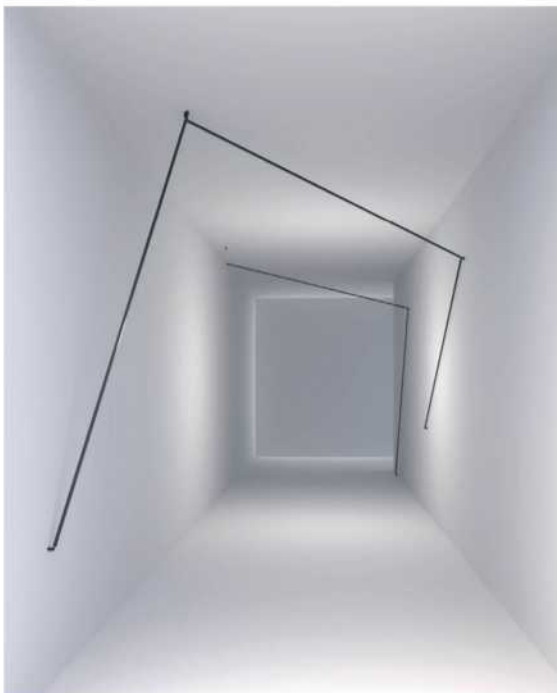



#### SISTEMA

Cada componente, seja de piso ou parede, permite vários níveis de articulação, e o componente teto com ajustes de altura. O sistema completo pode ter única alimentação por parede ou teto.

## CONEXÕES

### PAREDE - PADERE / TETO - TETO

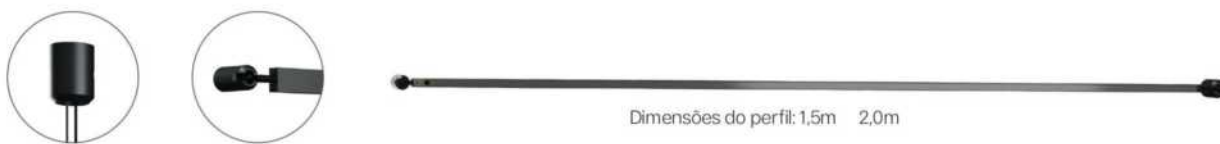

### PENDENTE - PENDENTE



### PAREDE - PENDENTE



### PISO - PENDENTE



### PENDENTE - PAREDE









A dimly lit conference room with a long table and chairs, featuring a large potted plant and framed artwork.

TELA  
TENSIONADA



# FLEX LIGHT

Tela tensionada Flex Light permite projetar soluções luminotécnicas personalizadas com design e formas adaptáveis a qualquer solução de arquitetura interior.

## INFORMAÇÕES GERAIS

Perfil em alumínio extrudado

 Fita LED / LED integrado

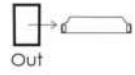

## CONTROLE



## DISTRIBUIÇÃO DE LUZ



## DESENHOS TÉCNICOS

Perfil alinhado



Perfil recuado



Transmissibilidade  
de luz 75%

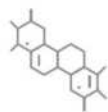

Termo retrátil com  
memória molecular



Material não propagador  
de chamas



Baixa carga: 0,5kg/m<sup>2</sup>  
com estrutura



Material Impermeável





